

**B&W Printers**  
**(M012/M013/M120-EU)**  
**Parts Catalog**

**Parts change information sample**

 **Add**

 **Update**

 **Delete**

Model	Product Code	PC Style
B/W Printer	M012/M013/M120	3D
Paper Feed Unit TK 1080	M355	3D

# Unit All

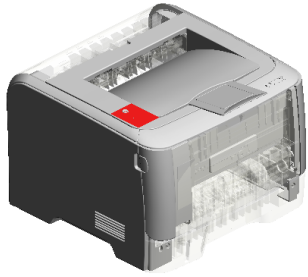

U001  
EXTERIOR

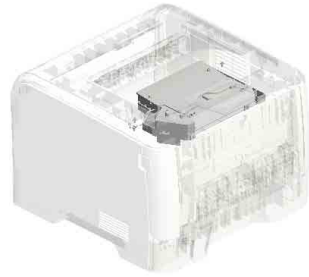

U002  
LASER UNIT

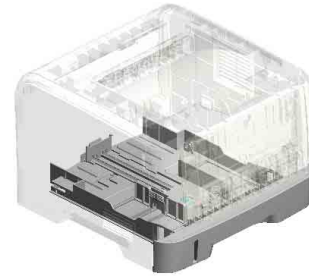

U003  
PAPER TRAY

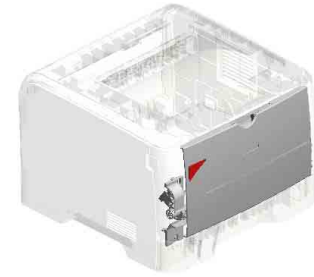

U004  
MANUAL FEED

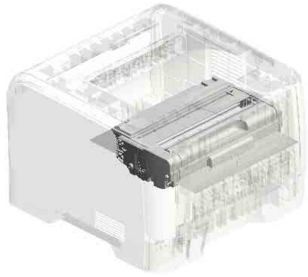

U005  
PCU

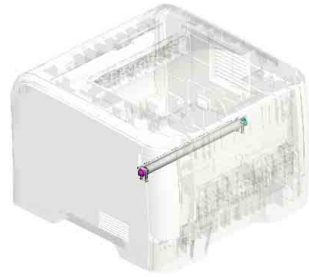

U006  
TRANSFER/SEPARATION

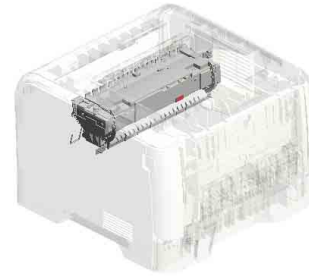

U007  
FUSING

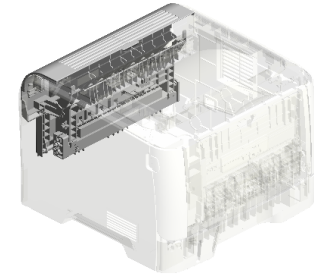

U008  
DUPLEX(Vertical paper feed)

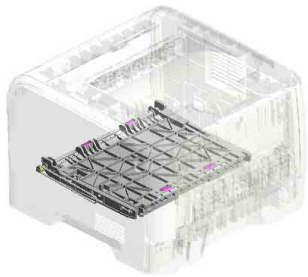

U009  
DUPLEX(Horizontal paper feed)

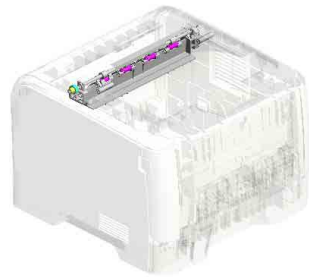

U010  
PAPER EXIT

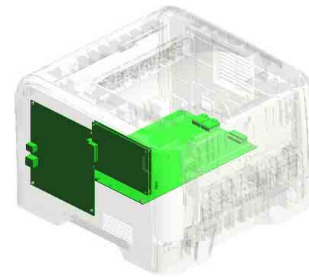

U011  
ELECTRICAL

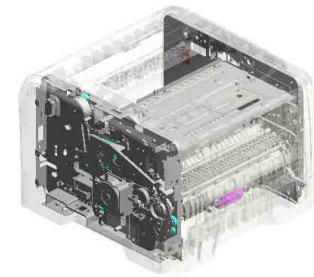

U012  
MAIN FRAME/PAPER FEED

# U001.EXTERIOR

U001\_S001  
M1201255  
COVER:UPPER:EU:ASSY:(for  
M120)



U001\_S002  
M0120050  
OPERATION PANEL:ASSY

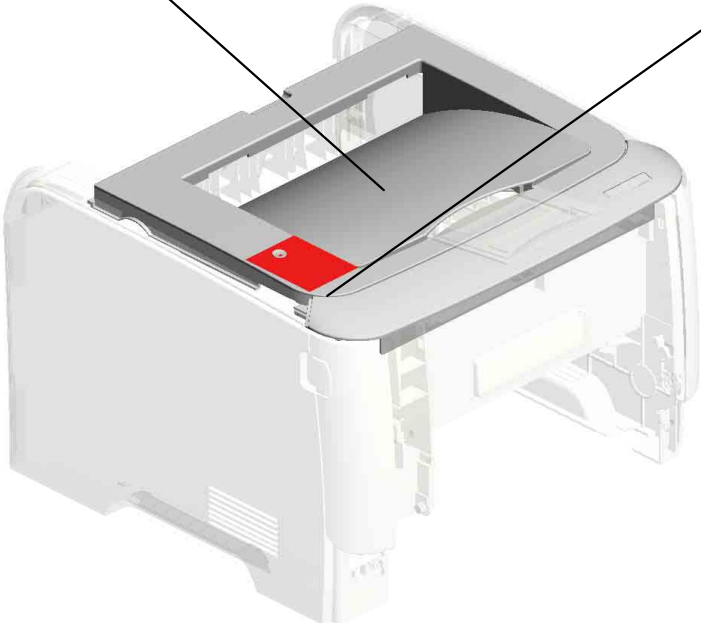
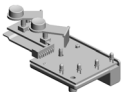

U001	U002	U003	U004	U005	U006	U007	U008	U009	U010	U011	U012
------	------	------	------	------	------	------	------	------	------	------	------

# U001 EXTERIOR

17.M0121350  
GUIDE PLATE:(for  
M012)

9.M0121302  
COVER:UPPER:(for  
M012/M013)

16.M0121341  
COVER:RIGHT UP  
PER:TRANSPAREN  
T

23.M0121325  
[A]  
201010-06 X/O

22.M0121324  
201010-02 X/O

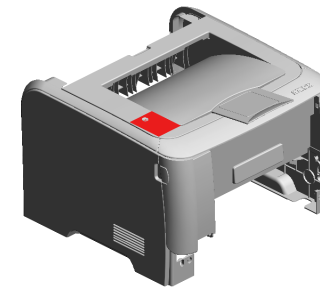

14.M0121331  
COVER:LEFT UP  
PER:TRANSPARENT

1.04503008N  
(x2)  
TAPPING SCREW -  
M3X8

18.M0121360  
COVER:REAR MID  
DLE

19.M0121370  
COVER:REAR LO  
WER

13.M0121330  
COVER:LEFT

3.04513006N  
(x8)  
TAPPING SCREW -  
3X6

4.G0521518  
SPRING - LOCK LE  
VER

7.M0121300  
COVER:FRONT

21.M0132630  
DECAL:PICK-UP P  
APER JAM:(for M01  
3)

5.J0121508  
PLATE:LOGO:RIC  
H

15.M0121340  
COVER:RIGHT:220  
V

10.M0121311  
COVER:UPPER FR  
ONT:TRANSPARE  
NT

8.M0121301  
BUTTON:RIGHT

20.M0122630  
DECAL:PICK-UP P  
APER JAM:(for M01  
2)



M0121321  
[A]  
EXTENSION TRAY:  
GUIDE  
201010-02 X/O

U001\_S001  
COVER:UPPER:EU:ASS'Y:(for M120)

24.M1200408  
DECAL:OPERATIO  
N SUB-UNIT:EU:(for  
M120)  
201112-04

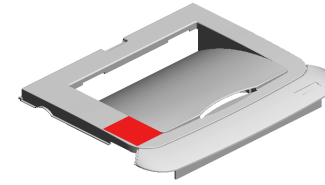
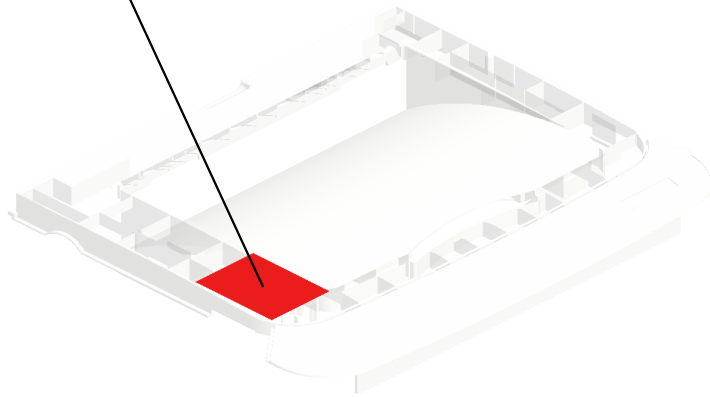

25.M1201255  
COVER:UPPER:EU  
:ASS'Y:(for M120)  
201112-05

U001\_S002  
OPERATION PANEL:ASS'Y

2.04503010N  
(x2)  
TAPPING SCREW -  
M3X10

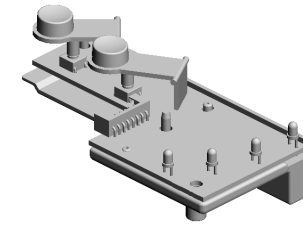
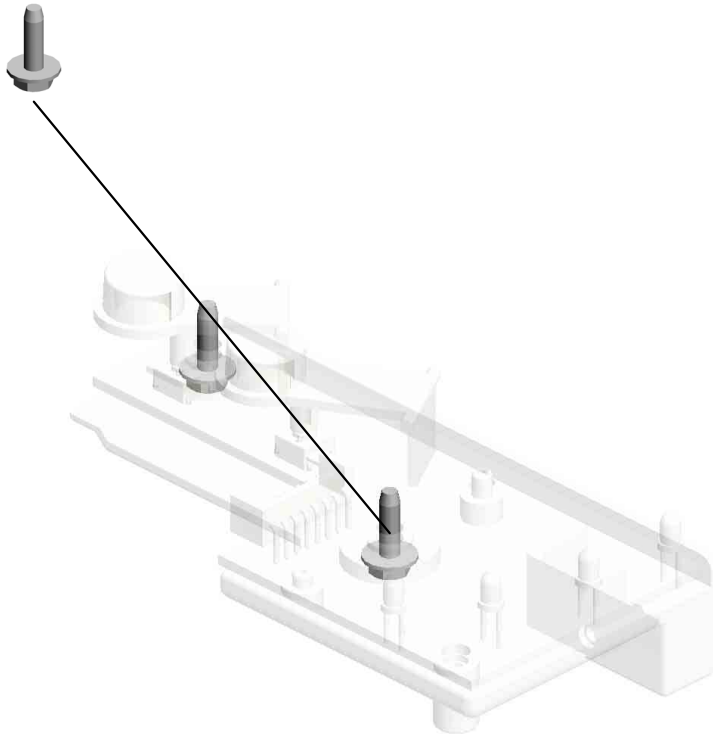

6.M0120050  
OPERATION PANE  
L:ASS'Y

U001	U002	U003	U004	U005	U006	U007	U008	U009	U010	U011	U012
------	------	------	------	------	------	------	------	------	------	------	------



# U002.LASER UNIT

U002\_S001  
M0121851  
IMAGING UNIT

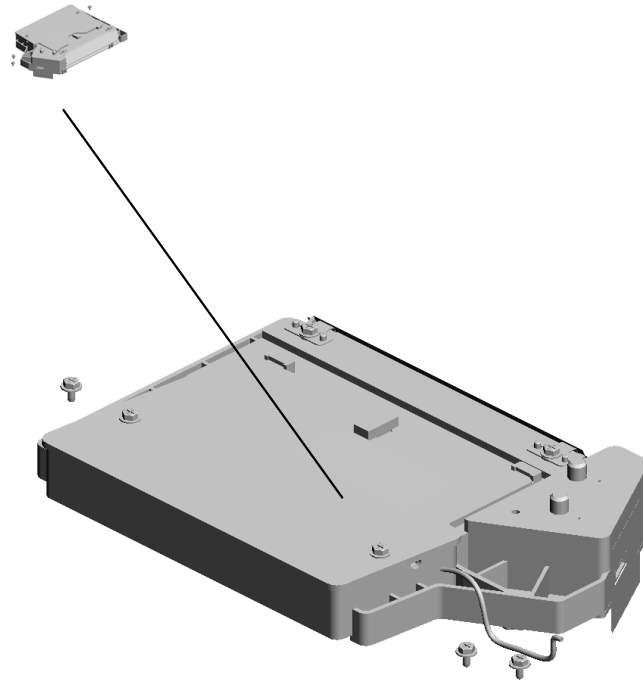

U001	<b>U002</b>	U003	U004	U005	U006	U007	U008	U009	U010	U011	U012
------	-------------	------	------	------	------	------	------	------	------	------	------

U002  
LASER UNIT

4.04543008Q  
(x3)  
TAPPING SCREW:  
3X8

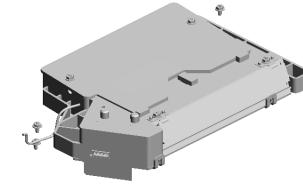

# U002\_S001 IMAGING UNIT

6.M0121957  
POLYGON MOTOR  
:DC 18W

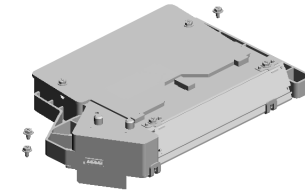

5.M0121851  
IMAGING UNIT

1.04503008N  
(x4)  
TAPPING SCREW -  
M3X8

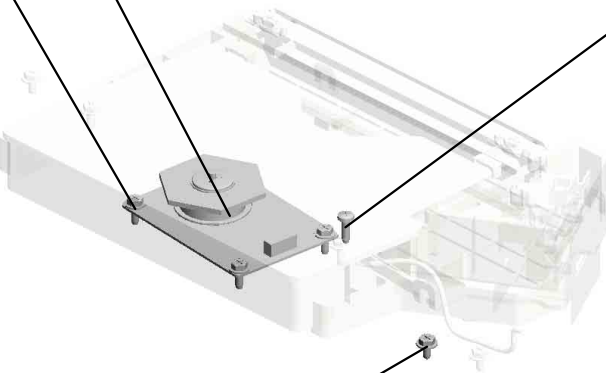
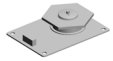

3.04523010N  
BINDING SELF-TA  
PPING SCREW:3X  
10



2.04513006N  
TAPPING SCREW -  
3X6



U001	<b>U002</b>	U003	U004	U005	U006	U007	U008	U009	U010	U011	U012
------	-------------	------	------	------	------	------	------	------	------	------	------

# U003.PAPER TRAY

U003\_S001  
M0122610  
TRAY BOTTOM PLATE

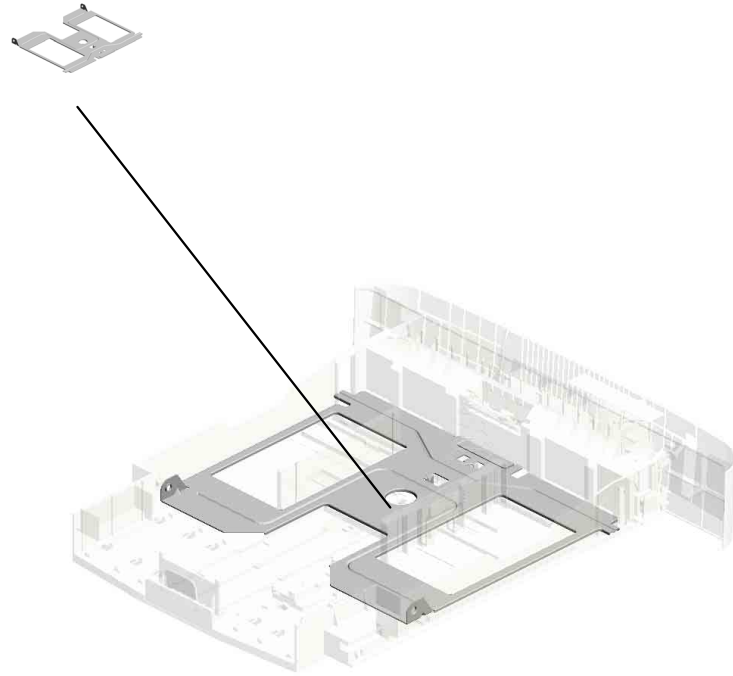

U001	U002	U003	U004	U005	U006	U007	U008	U009	U010	U011	U012
------	------	------	------	------	------	------	------	------	------	------	------

# U003 PAPER TRAY

6.M0122603 STOPPER:BASE PLATE  
 14.M0122615 SIDE FENCE:RIGHT  
 11.M0122612 COMPRESSION SPRING:TRAY BOTTOM PLATE  
 8.M0122605 FRICTION PAD:ADHESION

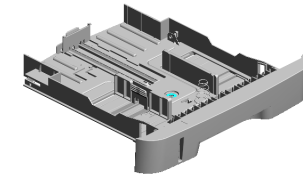

3.M0122504  
PAPER TRAY

1.G8003133  
SIDE FENCE GEAR



4.M0122589  
PAPER TRAY:REAR



9.M0122608  
END FENCE

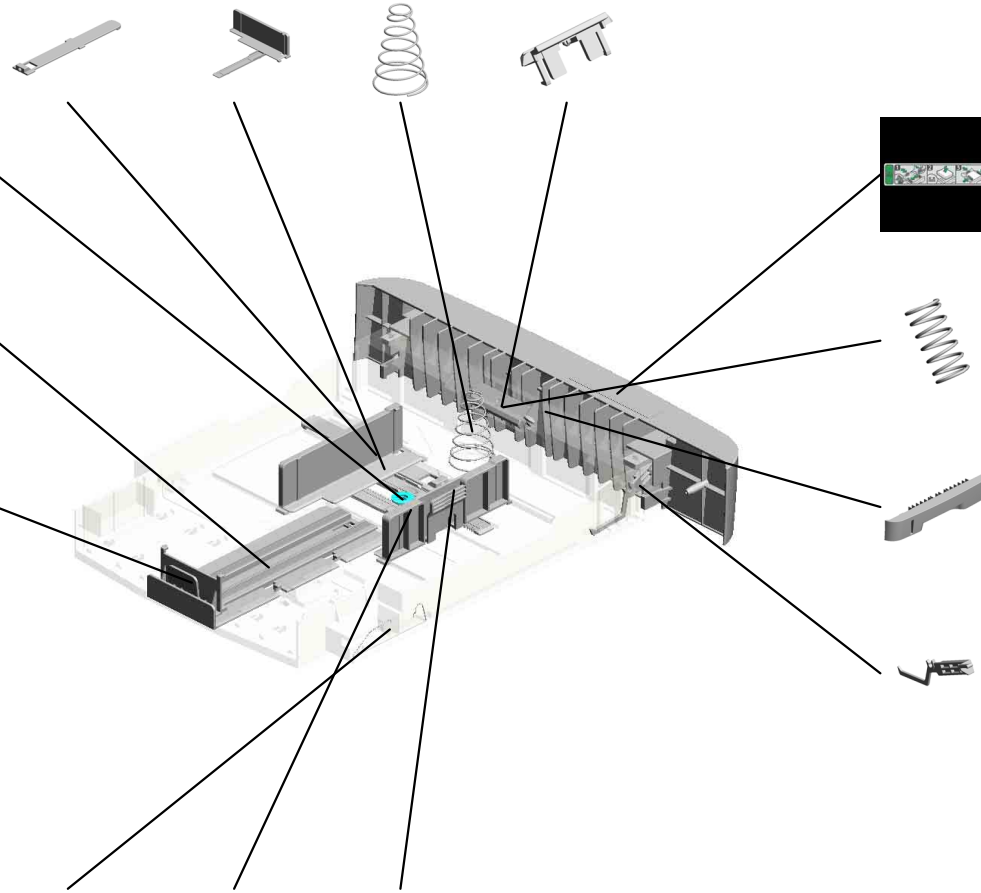

16.M0122618  
DECAL:PAPER TRAY:FRONT

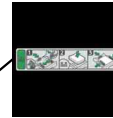

12.M0122613  
COMPRESSION SPRING:SEPARATION



17.M0122629  
COVER:PAPER TRAY



15.M0122616  
LEVER:PAPER VOLUME SENSOR



5.M0122590  
COIL SPRING:EAR TH



13.M0122614  
SIDE FENCE:LEFT



7.M0122604  
SPRING:RELEASE:TRAY BOTTOM PLATE



U003\_S001  
TRAY BOTTOM PLATE

2.GF013001  
BOTTOM PLATE P  
AD

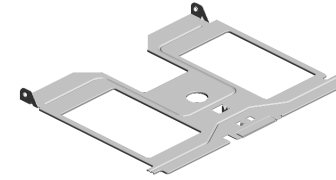
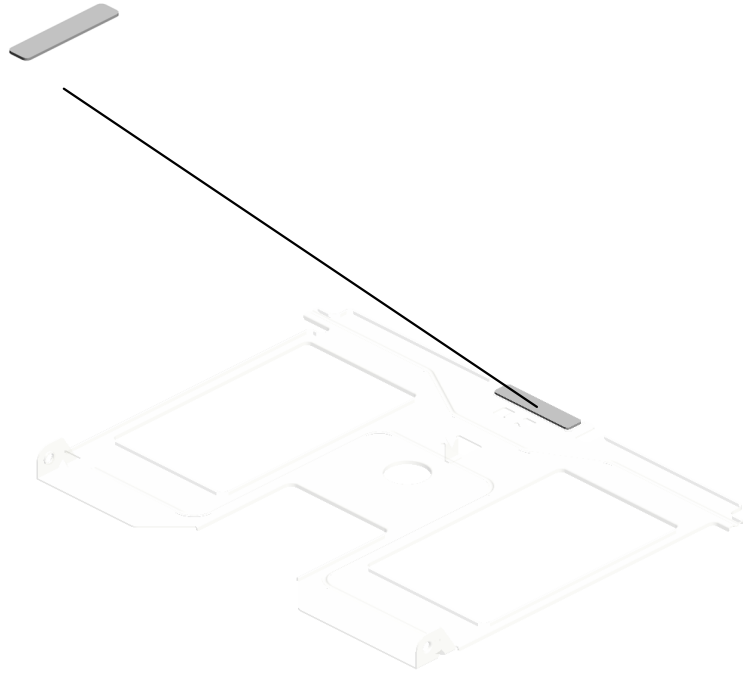

10.M0122610  
TRAY BOTTOM PL  
ATE

U001	U002	U003	U004	U005	U006	U007	U008	U009	U010	U011	U012
------	------	------	------	------	------	------	------	------	------	------	------

# U004.MANUAL FEED

U004\_S001  
M0122869  
MANUAL FEED TABLE:SUB-A  
SS'Y

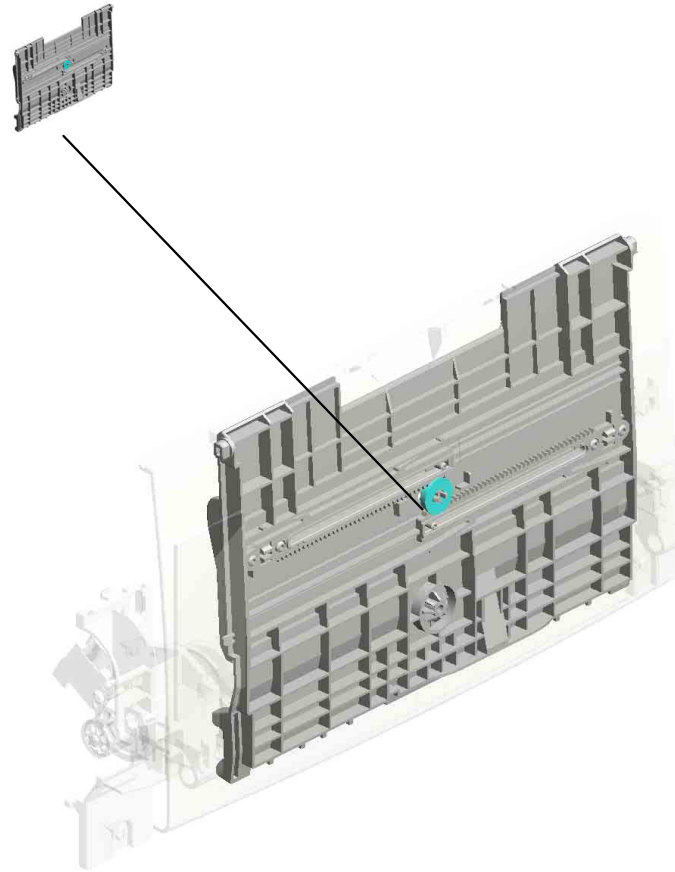

U001	U002	U003	U004	U005	U006	U007	U008	U009	U010	U011	U012
------	------	------	------	------	------	------	------	------	------	------	------

# U004 MANUAL FEED

20.M0122860  
PAPER FEED ROLLER:MANUAL FEED

12.M0122806  
SHEET:GUIDE:MANUAL FEED SUB-UNIT

19.M0122859  
GUIDE PLATE:UPPER:MANUAL FEED

22.M0122870  
COVER:MANUAL FEED TABLE

26.M0122879  
EXTENSION TRAY:MANUAL FEED

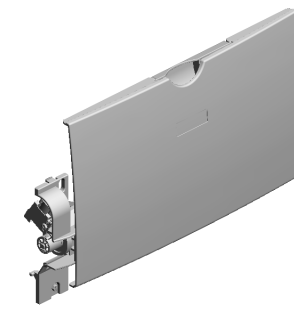

13.M0122815  
DECAL:FEED PAPER AGAIN:PREVENTION



17.M0122831  
DC SOLENOID:9.6W:24V



6.G1022717  
COVER:DC SOLENOID



2.04523010N  
BINDING SELF-TAPPING SCREW:3X10



16.M0122830  
MECHANICAL SPRING CLUTCH:MANUAL FEED



11.M0122805  
GUIDE PLATE:MANUAL FEED:LOWER



27.M0122880  
COMPRESSION SPRING:SEPARATION



14.M0122816  
FRICTION PAD:HOLDER:MANUAL FEED:ASSY



5.G0292767  
BY-PASS FEED COVER



23.M0122874  
COMPRESSION SPRING:MANUAL FEED



3.AA143520  
SHOULDER SCREW - M3



10.GW020020  
PHOTOINTERRUPTOR:LG248NL1



8.G1022789  
STOPPER:PHOTO INTERRUPTOR



15.M0122824  
FEELER:MANUAL FEED



1.04513006N (x3)  
TAPPING SCREW - 3X6





U004\_S001  
 MANUAL FEED TABLE:SUB-ASS'Y

18.M0122833 4.G0123050  
 DECAL:SIDE FENC SIDE FENCE GEAR  
 E:MANUAL FEED

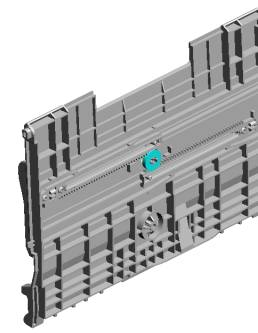

21.M0122869  
 MANUAL FEED TA  
 BLE:SUB-ASS'Y

24.M0122875  
 SIDE FENCE:MAN  
 UAL FEED:RIGHT

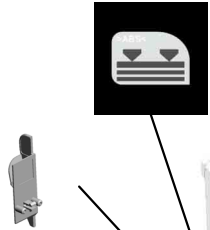

7.G1022755  
 (x2)  
 RACK:SIDE FENCE  
 :REAR



25.M0122877  
 SIDE FENCE:MAN  
 UAL FEED:LEFT



9.GF013001  
 BOTTOM PLATE P  
 AD



U001	U002	U003	U004	U005	U006	U007	U008	U009	U010	U011	U012
------	------	------	------	------	------	------	------	------	------	------	------

U005  
PCU

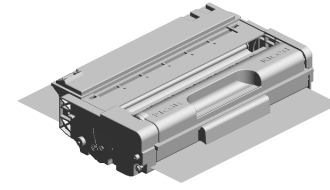

U001	U002	U003	U004	U005	U006	U007	U008	U009	U010	U011	U012
------	------	------	------	------	------	------	------	------	------	------	------

# U006 TRANSFER/SEPARATION

7.M0126259  
ELECTRODE PLAT  
E:SEPARATION

8.M0126260  
COVER:ELECTRO  
DE PLATE

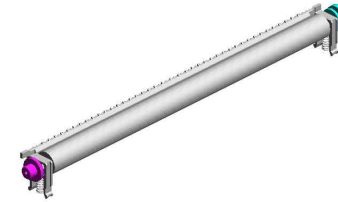

6.M0126256  
ROLLER:POSITION  
ING:TRANSFER R  
OLLER



3.M0126253  
BUSHING:TRANSF  
ER ROLLER:LEFT



5.M0126255  
GEAR:TRANSFER  
ROLLER



2.M0126252  
BUSHING:TRANSF  
ER ROLLER:RIGHT



1.M0126250  
TRANSFER ROLLE  
R:ASS'Y



4.M0126254  
(x2)  
SPRING:TRANSFE  
R ROLLER

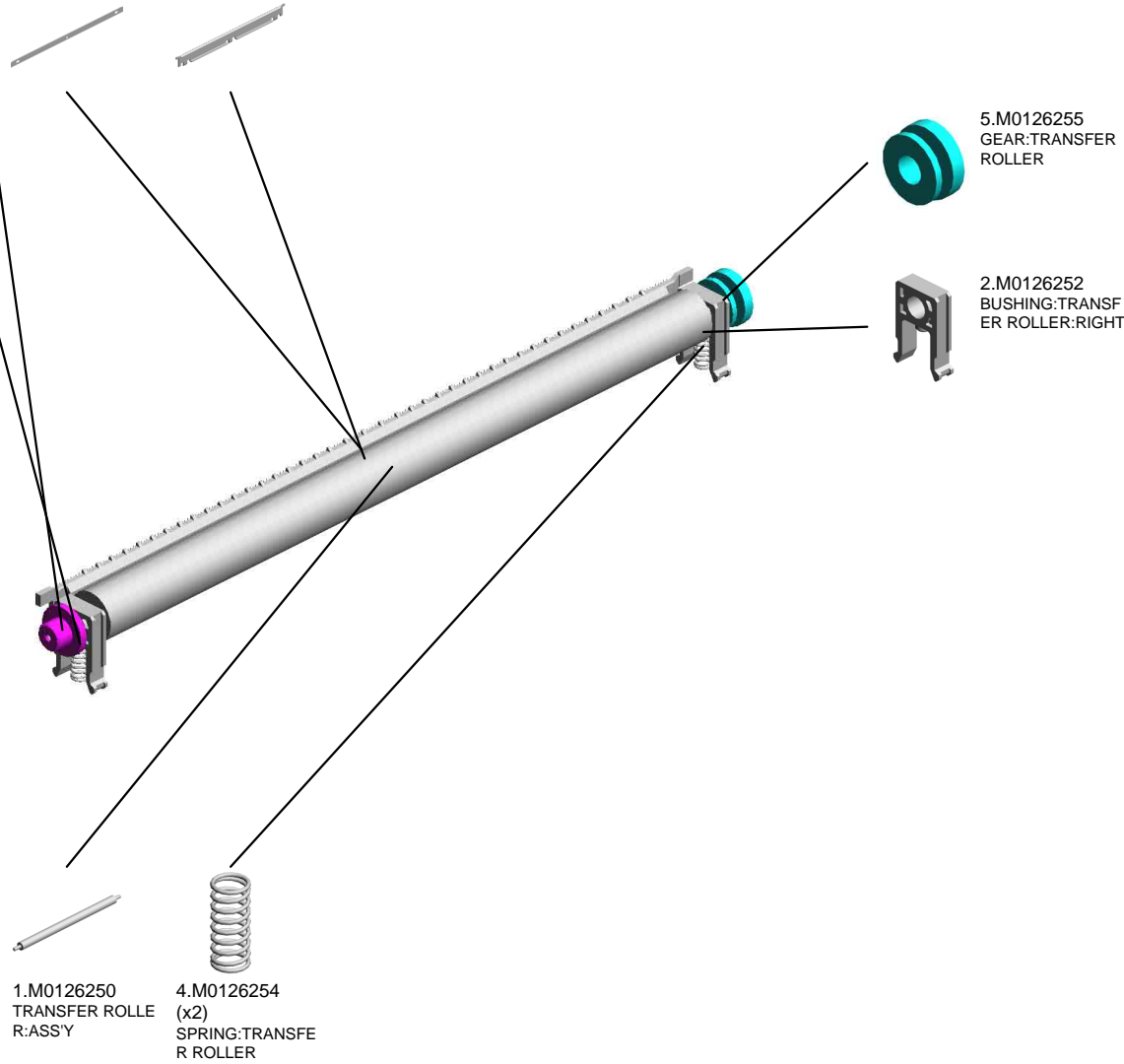

# U007.FUSING

U007\_S001  
M0124031  
FUSING UNIT:220V

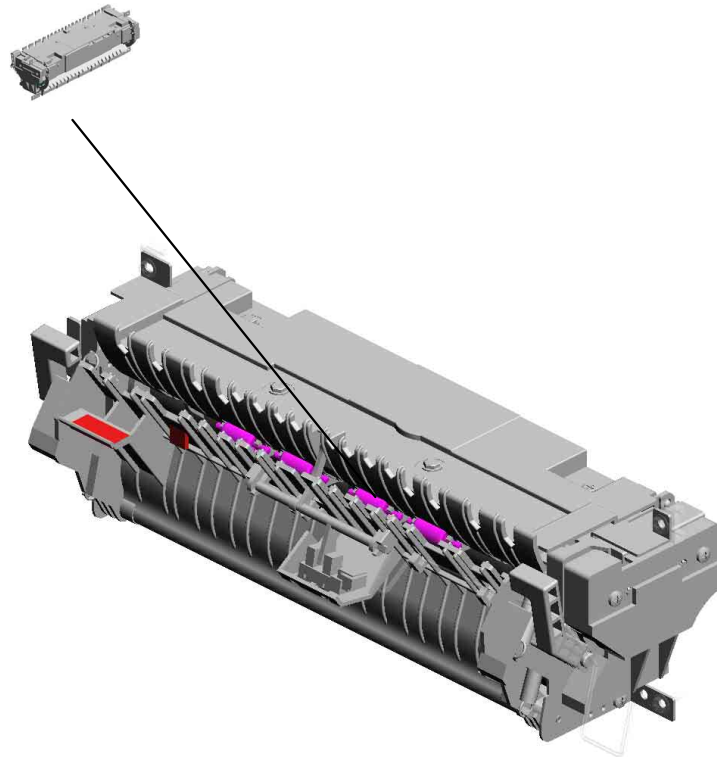

U001	U002	U003	U004	U005	U006	U007	U008	U009	U010	U011	U012
------	------	------	------	------	------	------	------	------	------	------	------

# U007 FUSING

50.M0124699  
DECAL:WARNING (HIGH TEMPERATURE):FRONT



3.04513008N  
(x2)  
TAPPING SCREW - M3X8

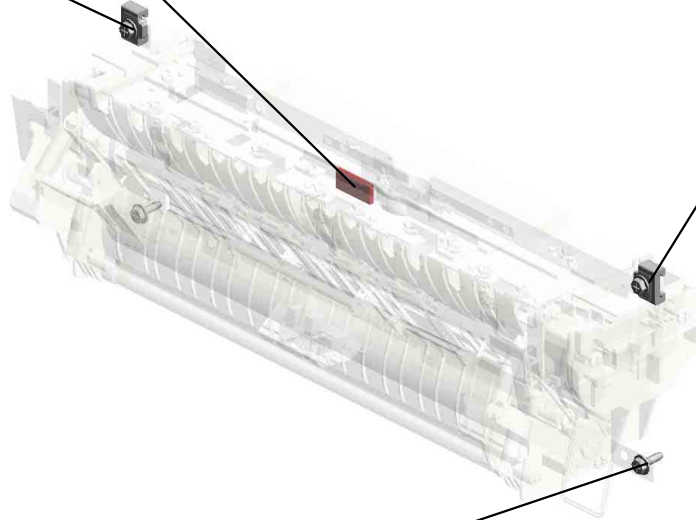

39.M0124270  
(x2)  
THERMAL INSULATING BUSHING:FUSING UNIT

2.04503010N  
(x2)  
TAPPING SCREW - M3X10

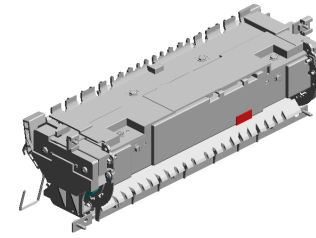

U001	U002	U003	U004	U005	U006	U007	U008	U009	U010	U011	U012
------	------	------	------	------	------	------	------	------	------	------	------

U007\_S001  
FUSING UNIT:220V

9.AA143520  
(x7)  
SHOULDER SCREW - M3

18.M0124121  
HEATER:700W:220V

7.08046127  
(x4)  
HEXAGONAL BOLT :DOUBLE SCREW: M3X8

8.09543010N  
SCREW:POLISHED ROUND/SPRING:M 3X10

10.AW110058  
THERMOSTAT:177

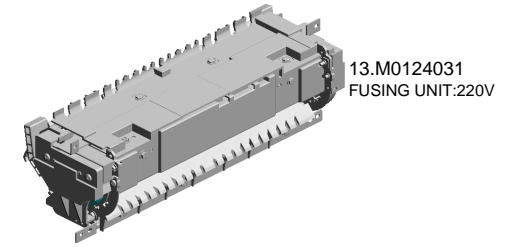

13.M0124031  
FUSING UNIT:220V

11.G1274328  
DECAL - HIGH TEMPERATURE



4.04533006N  
(x6)  
TAPPING SCREW - M3X6



16.M0124109  
SPRING:FEELER:EXIT



19.M0124135  
FEELER:PAPER FEED SENSOR



12.GW020020  
PHOTOINTERRUPTOR:LG248NL1



1.03603006N  
(x11)  
SCREW - M3X6



17.M0124120  
(x3)  
TENSION SPRING: PICKOFF PAWL



21.M0124202  
(x2)  
LEVER:PRESSURE



5.07200040E  
(x2)  
RETAINING RING - M4



3.04513008N  
(x4)  
TAPPING SCREW - M3X8



6.08025318  
(x4)  
BINDING HEAD TAPPING SCREWS: 3X10



20.M0124186  
COVER:LEFT UPPER:ASSY

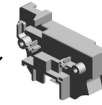

22.M0124204  
LEVER:LEFT:FRAME:FUSING



15.M0124055  
(x2)  
RADIAL BALL BEARING:35X47X7



14.M0124053  
GEAR:HOT ROLLER



U007\_S001  
FUSING UNIT:220V

- 42.M0124281 (x2) RETAINING RINGS  
-C:HOT ROLLER
- 33.M0124223 THERMAL INSULATING BUSHING:HOT ROLLER
- 23.M0124205 LEVER:RIGHT:FRA  
ME:FUSING
- 37.M0124263 THERMISTOR:FUSING
- 35.M0124234 HOUSING:THERM  
OSTAT:ASSY

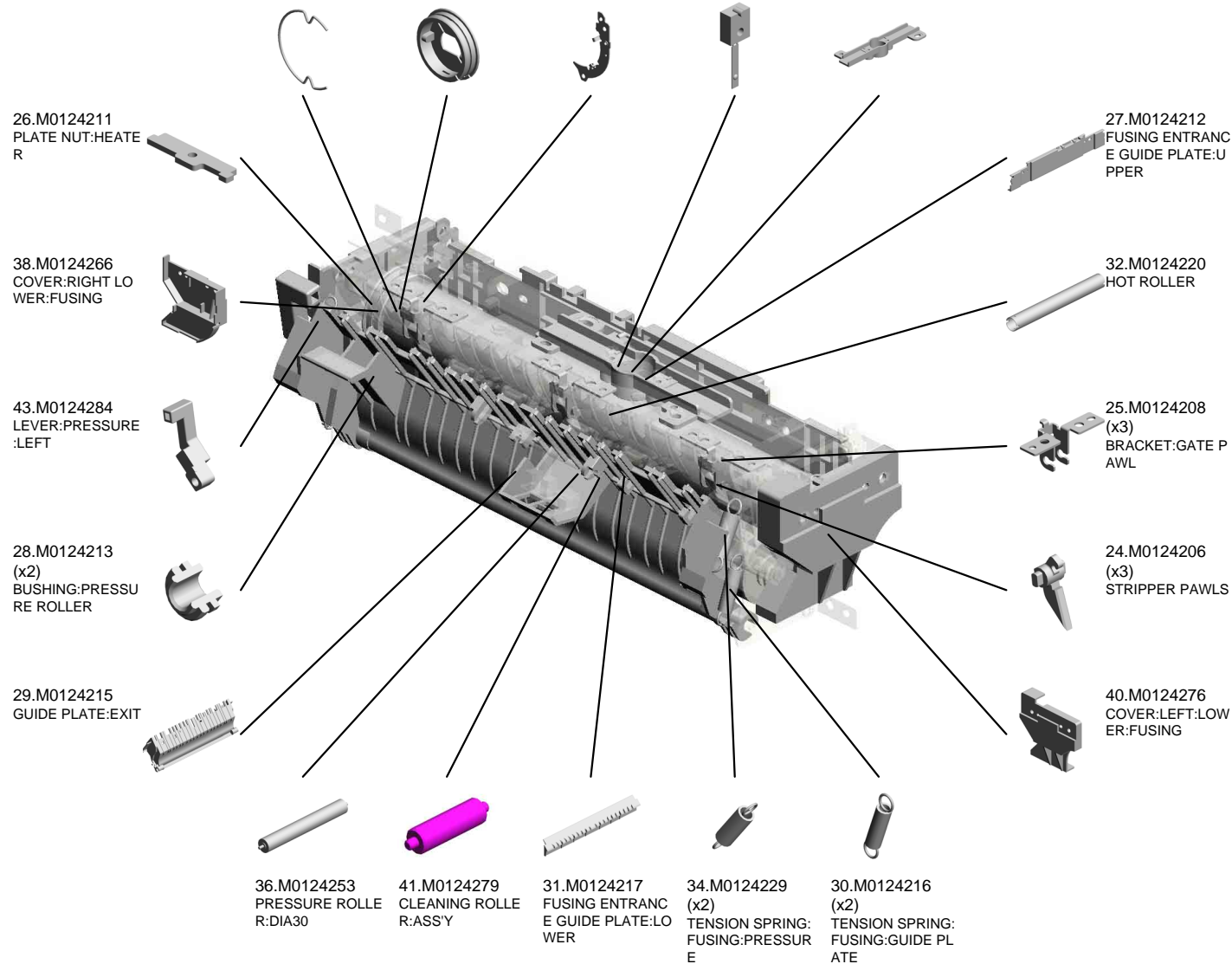
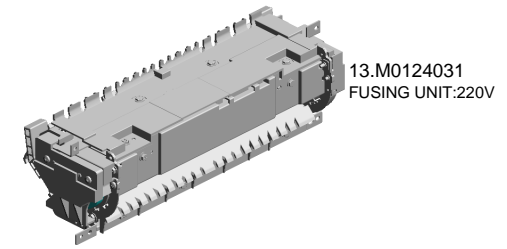

U007\_S001  
FUSING UNIT:220V

45.M0124287  
COVER:RIGHT UP  
PER:FUSING

48.M0124295  
GROUND PLATE:A  
SS'Y

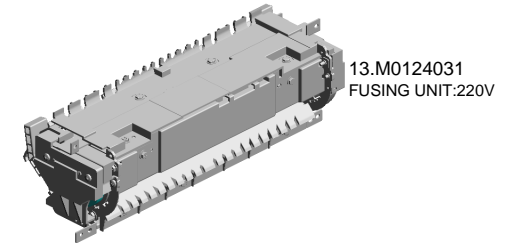

49.M0124603  
DECAL:GUIDE PLATE:B

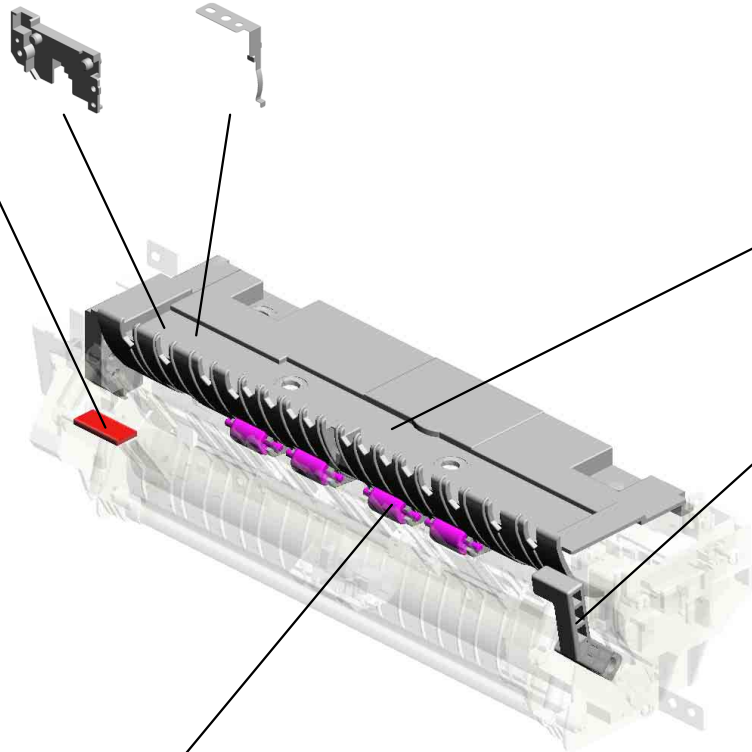
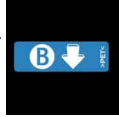

46.M0124292  
FUSING COVER:UPPER



44.M0124285  
LEVER:PRESSURE:RIGHT



47.M0124293  
(x4)  
EXIT ROLLER:EXIT:FUSING



U001	U002	U003	U004	U005	U006	U007	U008	U009	U010	U011	U012
------	------	------	------	------	------	------	------	------	------	------	------



# U008 DUPLEX(Vertical paper feed)

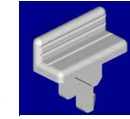
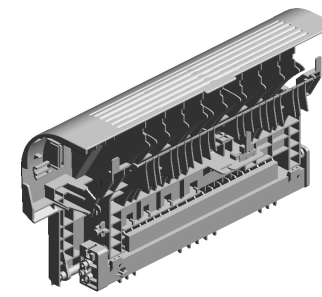
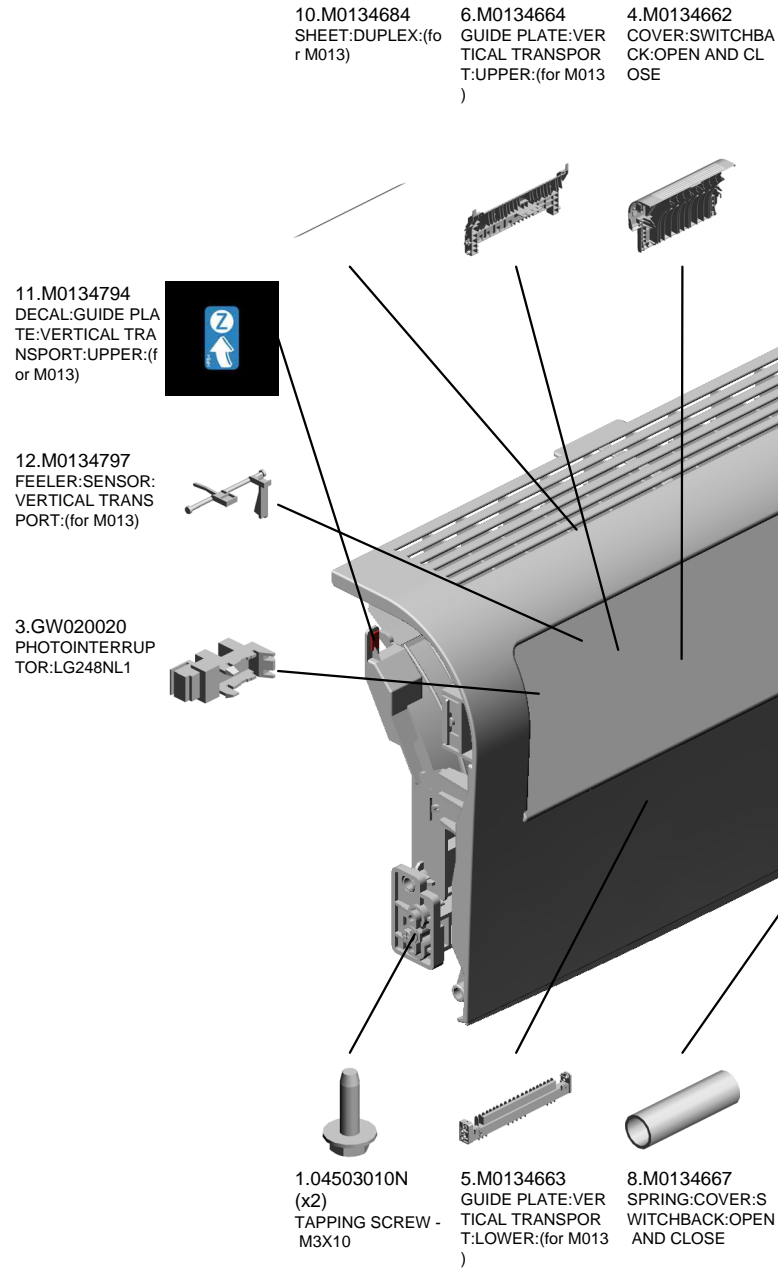

13.M0134661  
STOPPER:TRANSPORT SUB-UNIT:DUPLX

# U009 DUPLEX(Horizontal paper feed)



- 10.M0134672 SHEET:HORIZONTAL TRANSPORT:RI GHT:(for M013)
- 4.GW020020 PHOTOINTERUP TOR:LG248NL1
- 16.M0134761 TRANSPORT ROLL ER:DUPLX:MIDDL E:(for M013)
- 7.M0134624 (x2) SPRING:EXIT:NO.2 :(for M013)
- 9.M0134671 SHEET:HORIZONTAL TRANSPORT:LE FT:(for M013)

**3.M0124488**  
(x4)  
[A]  
BUSHING:DIA6XDI A10X6 201203-03 X/O



12.M0134688 GROUND PLATE:H ORIZONTAL TRAN SPORT:REAR:(for M013)



18.M0134765 (x3) PULLEY:TRANSPOR T:(for M013)



2.08050089 (x6) RETAINING RING - M4



1.04503008N (x4) TAPPING SCREW - M3X8



8.M0134668 SHEET:GUIDE:HO RIZONTAL TRAN SPOR:LOWER:(for M013)



22.M0134795 (x4) PIN:GUIDE:UPPER: (for M013)



14.M0134694 GUIDE:HORIZONT AL TRANSPORT:U PPER:(for M013)



15.M0134695 GUIDE:HORIZONT AL TRANSPORT:L OWER:(for M013)

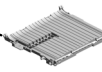

17.M0134762 TRANSPORT ROLL ER:DUPLX:EXIT:(f or M013)



21.M0134778 FEELER:SENSOR: HORIZONTAL TRA NSPORT:(for M013)



13.M0134691 LEVER:OPEN AND CLOSE:LOWER:(for M013)



11.M0134687 GROUND PLATE:H ORIZONTAL TRAN SPORT:FRONT:(for M013)



5.M0134622 (x4) EXIT ROLLER:DU PLEX:(for M013)



6.M0134623 (x2) SPRING:EXIT:(for M013)

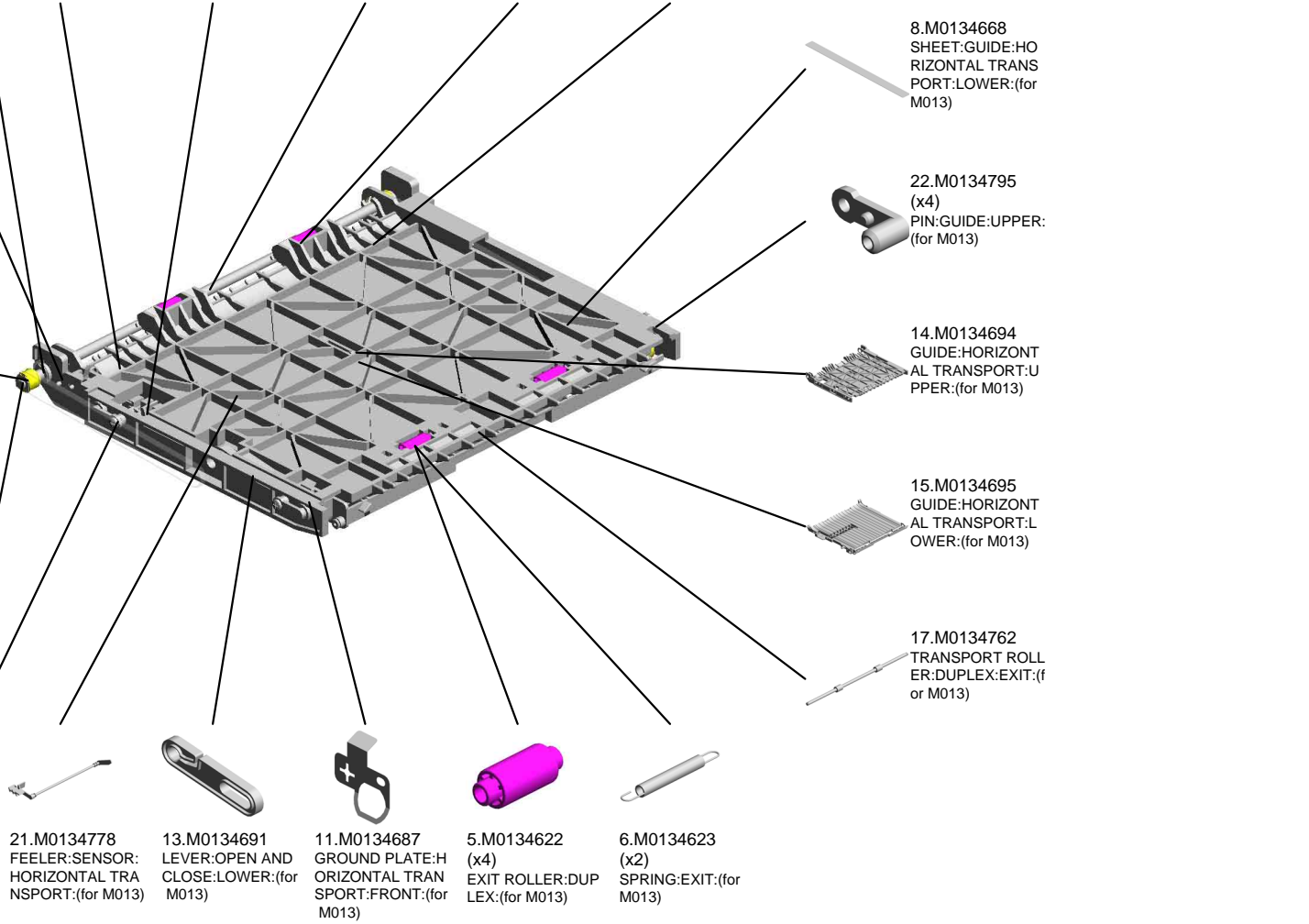

U009  
DUPLEX(Horizontal paper feed)

24.M0134772  
201010-05 O/O

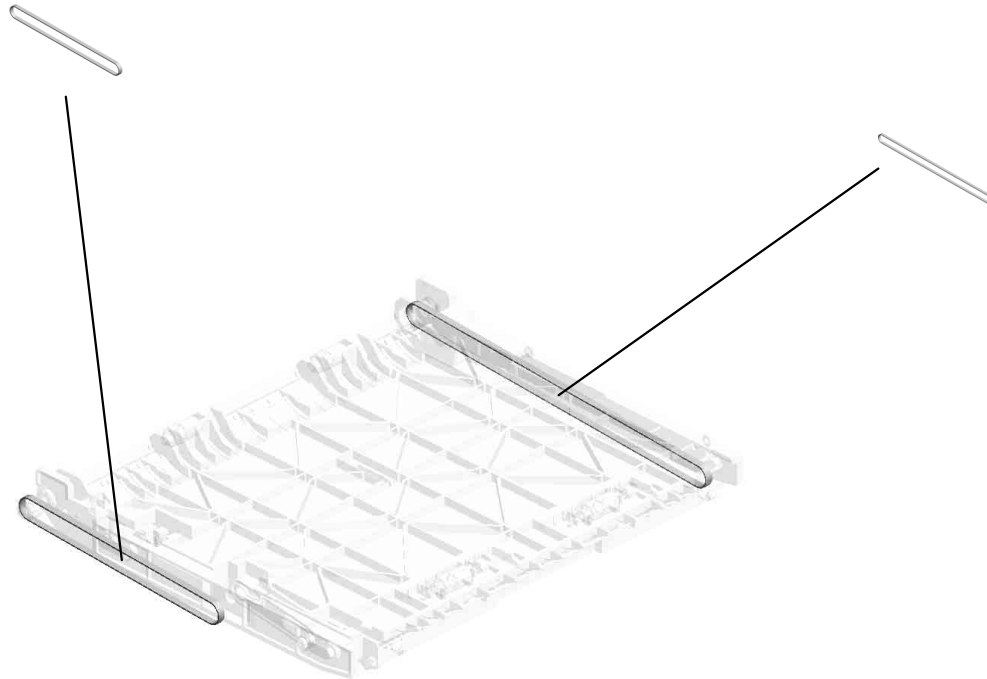

23.M0134771  
201010-04 O/O

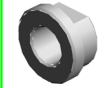

G1272575  
[A]  
BUSHING - 6X10X6  
201203-03 X/O

U001	U002	U003	U004	U005	U006	U007	U008	U009	U010	U011	U012
------	------	------	------	------	------	------	------	------	------	------	------

# U010 PAPER EXIT

- 4.M0124453 (x4) EXIT ROLLER
- 5.M0124454 (x4) SPRING:EXIT ROLLER:EXIT
- 7.M0124458 DISCHARGE BRUSH:EXIT:ASS'Y DRA WING
- 9.M0124470 EXIT ROLLER:ASS'Y:(for M012)

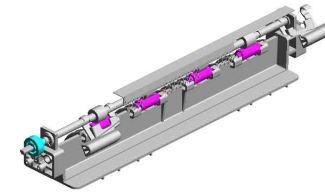

6.M0124457  
GROUND PLATE:EXIT:DISCHARGE BRUSH

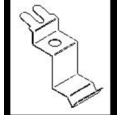

12.M0124499  
GROUND PLATE:EXIT ROLLER



11.M0124482  
PLATE:RIGHT:EXIT

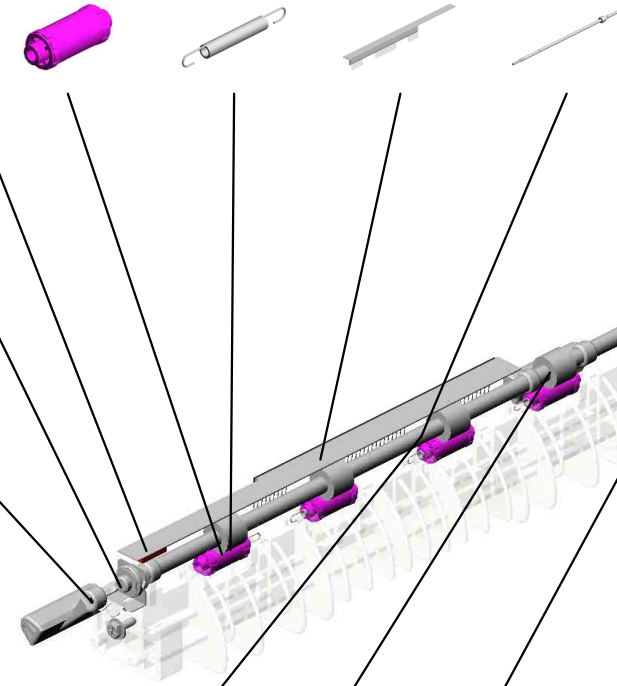

8.M0124465  
PULLEY:EXIT:(for M012)



13.M0134455  
GEAR:DRIVE:EXIT ROLLER:(for M013)



2.07200040E (x2)  
RETAINING RING - M4



3.M0124488 (x2)  
[A]  
BUSHING:DIA6XDI A10X6 201203-03 X/O

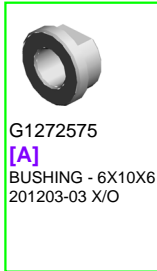
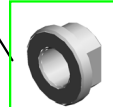

14.M0134470  
EXIT ROLLER:DUPLEX:(for M013)

10.M0124481  
PLATE:LEFT:EXIT

1.04503008N (x2)  
TAPPING SCREW - M3X8

# U011 ELECTRICAL

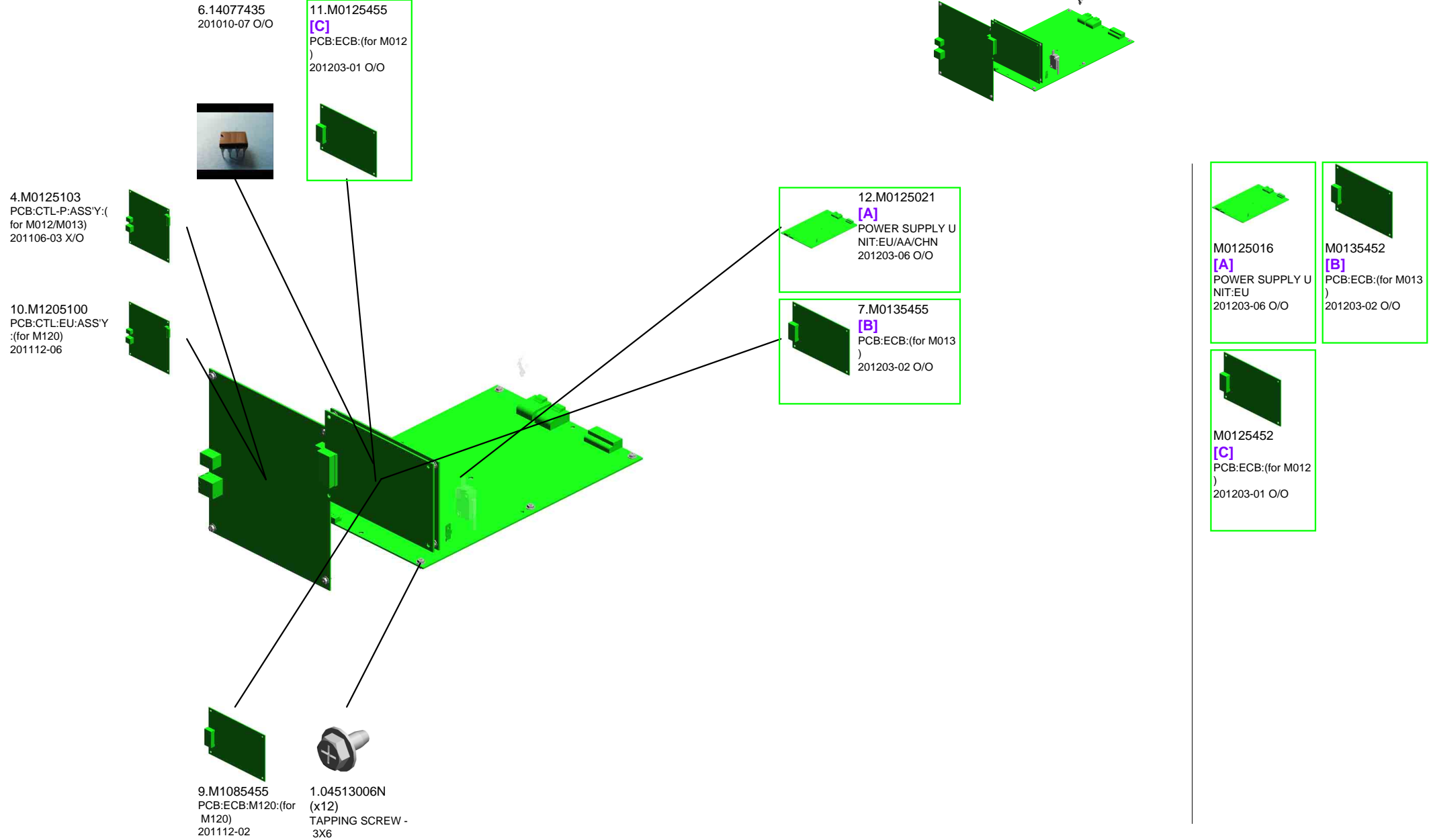

U001	U002	U003	U004	U005	U006	U007	U008	U009	U010	U011	U012
------	------	------	------	------	------	------	------	------	------	------	------

# U012.MAIN FRAME/PAPER FEED

U012\_S001  
M0125039  
MAIN SWITCH:SERVICE:ASS  
Y

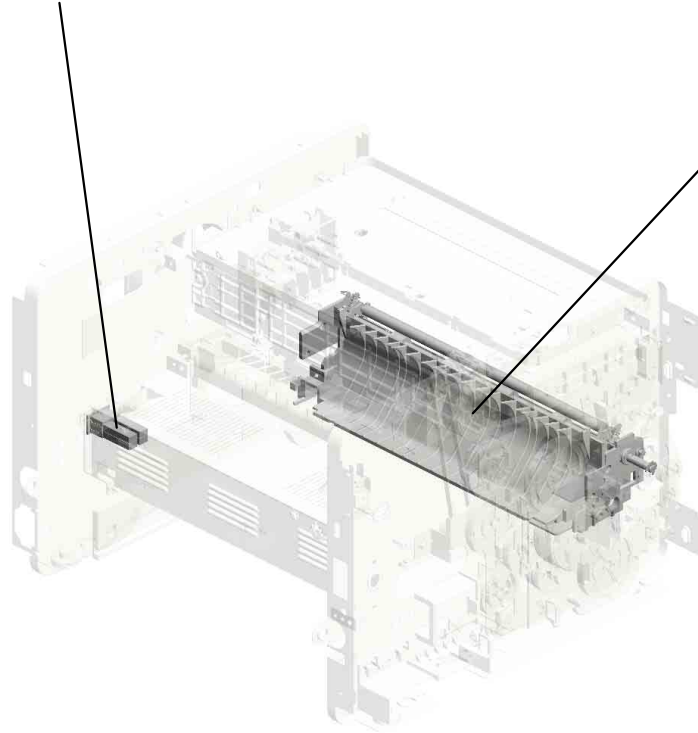
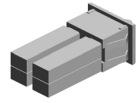

U012\_S002  
M0122516  
JOINT UNIT:ASSY

U001	U002	U003	U004	U005	U006	U007	U008	U009	U010	U011	U012
------	------	------	------	------	------	------	------	------	------	------	------

# U012 MAIN FRAME/PAPER FEED

1.04503008N (x12) TAPPING SCREW - M3X8  
 6.04543006Q (x9) TAPPING SCREW - M3X6  
 14.11050534 (x2) CLAMP  
 5.04533006N (x2) TAPPING SCREW - M3X6  
 20.G0201160 (x2) SNAP RING

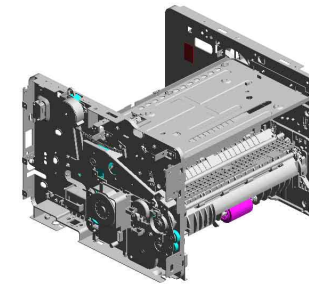

18.AX640199  
FAN:MM80:25MM:D  
C 2.16W



4.04513030N  
(x2)  
TAPPING SCREW:  
3X30



11.09504006N  
SCREW - M4X6



2.04513006N  
(x31)  
TAPPING SCREW -  
3X6



19.B2681085  
(x2)  
SWITCH:LF-105-11



7.04543014Q  
TAPPING SCREW:  
3X14



21.G0271180  
(x2)  
RUBBER FOOT - G  
F



8.07200040E  
RETAINING RING -  
M4



10.08050089  
(x12)  
RETAINING RING -  
M4



9.08050088  
RETAINING RING -  
M6



3.04513014N  
TAPPING SCREW:  
3X14



17.AX050265  
STEPPER MOTOR:  
DC24V 7.2W:(for M  
013)



16.A1532117  
ROLLER TERMINA  
L



13.11050511  
(x12)  
HARNESS CLAMP -  
LWS-0306ZC



12.11050508  
(x4)  
HARNESS CLAMP -  
LWS-0711



# U012 MAIN FRAME/PAPER FEED

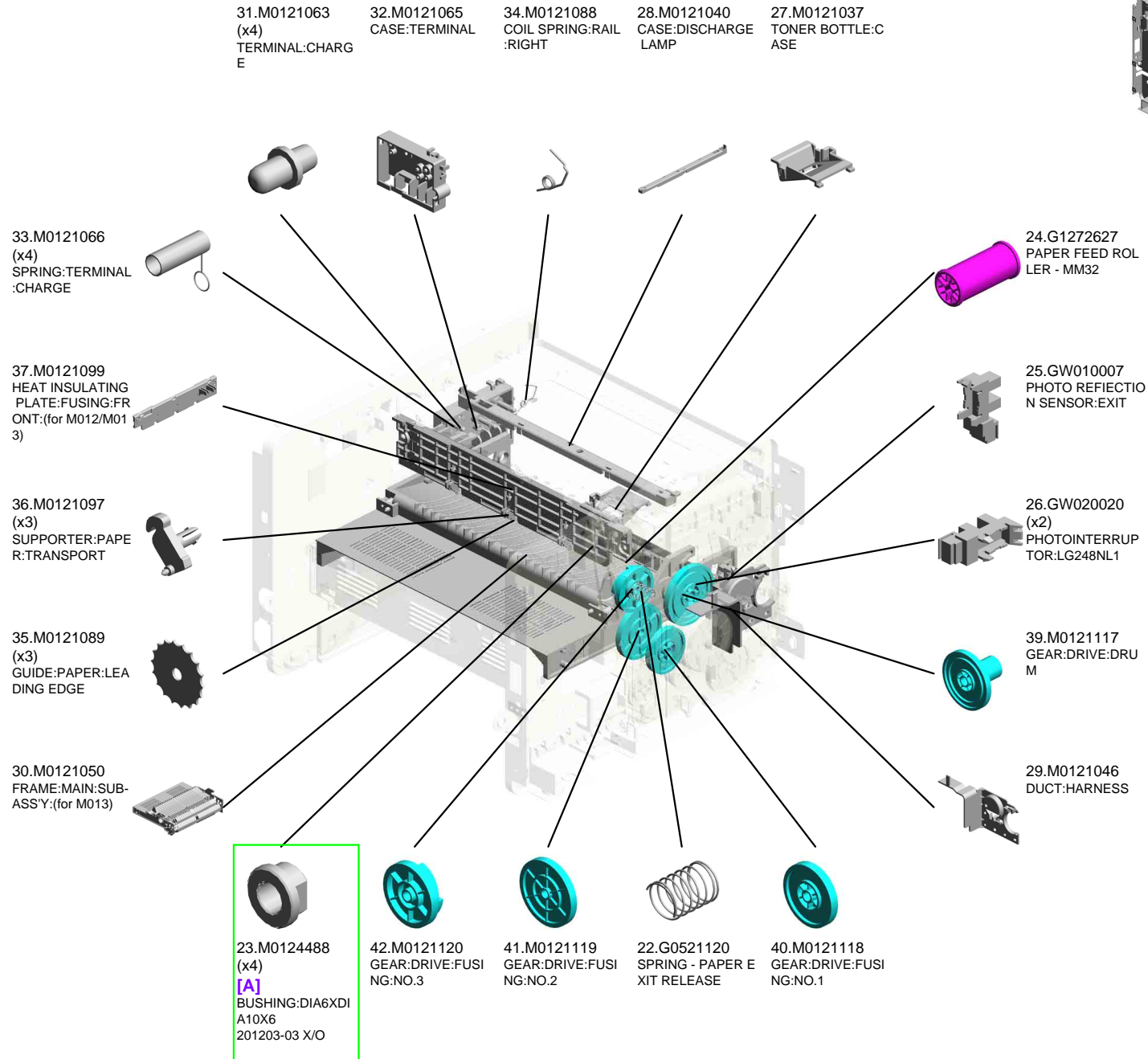
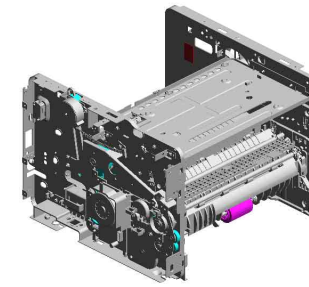

U001	U002	U003	U004	U005	U006	U007	U008	U009	U010	U011	U012
------	------	------	------	------	------	------	------	------	------	------	------



# U012 MAIN FRAME/PAPER FEED

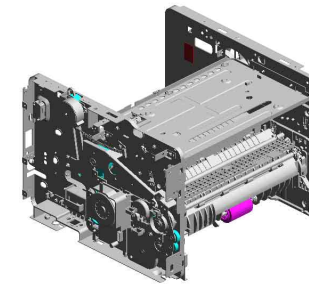

- 52.M0122056 DISCHARGE LAMP
- 64.M0122719 REGISTRATION ROLLER:DRIVEN
- 63.M0122717 REGISTRATION ROLLER:DRIVE
- 62.M0122715 GUIDE PLATE:TRANSPORT:UPPER
- 66.M0122723 FEELER:REGISTRATION:SENSOR

65.M0122722 (x2)  
SPRING:ROLLER:REGISTRATION



48.M0121128 GEAR:DRIVE:FUSION:NG:NO.4



57.M0122673 RAIL:PAPER TRAY:RIGHT



55.M0122671 FEELER:PAPER END SENSOR



47.M0121127 GEAR:DRIVE:EXIT:(for M012)



56.M0122672 RAIL:PAPER TRAY:LEFT



43.M0121121 GEAR:DRIVE:PAPER FEED:NO.1



49.M0121150 BRUSHLESS MOTOR:DC 36.7W



44.M0121122 GEAR:DRIVE:PAPER FEED:NO.2



46.M0121124 GEAR:DRIVE:PAPER FEED:NO.4



61.M0122711 BUSHING:REGISTRATION:DRIVEN:LEFT



54.M0122668 SHAFT:PAPER FEED:ASSY



51.M0121172 GEAR:DRIVE:MANUAL FEED SECTION:NO.2



45.M0121123 GEAR:DRIVE:PAPER FEED:NO.3



50.M0121171 GEAR:DRIVE:MANUAL FEED SECTION:NO.1



# U012 MAIN FRAME/PAPER FEED

- 68.M0122730 BUSHING:REGISTRATION:DRIVEN:RIGHT
- 85.M0134685 BUTTON:OPEN AND CLOSE:LOWER:(for M013)
- 71.M0122743 DECAL:GUIDE PLATE:TRANSPORT:UPPER
- 88.M0134698 BRACKET:OPEN AND CLOSE:LOWER:(for M013)
- 81.M0134610 GEAR:DRIVE:DUPLICATION:EX:(for M013)

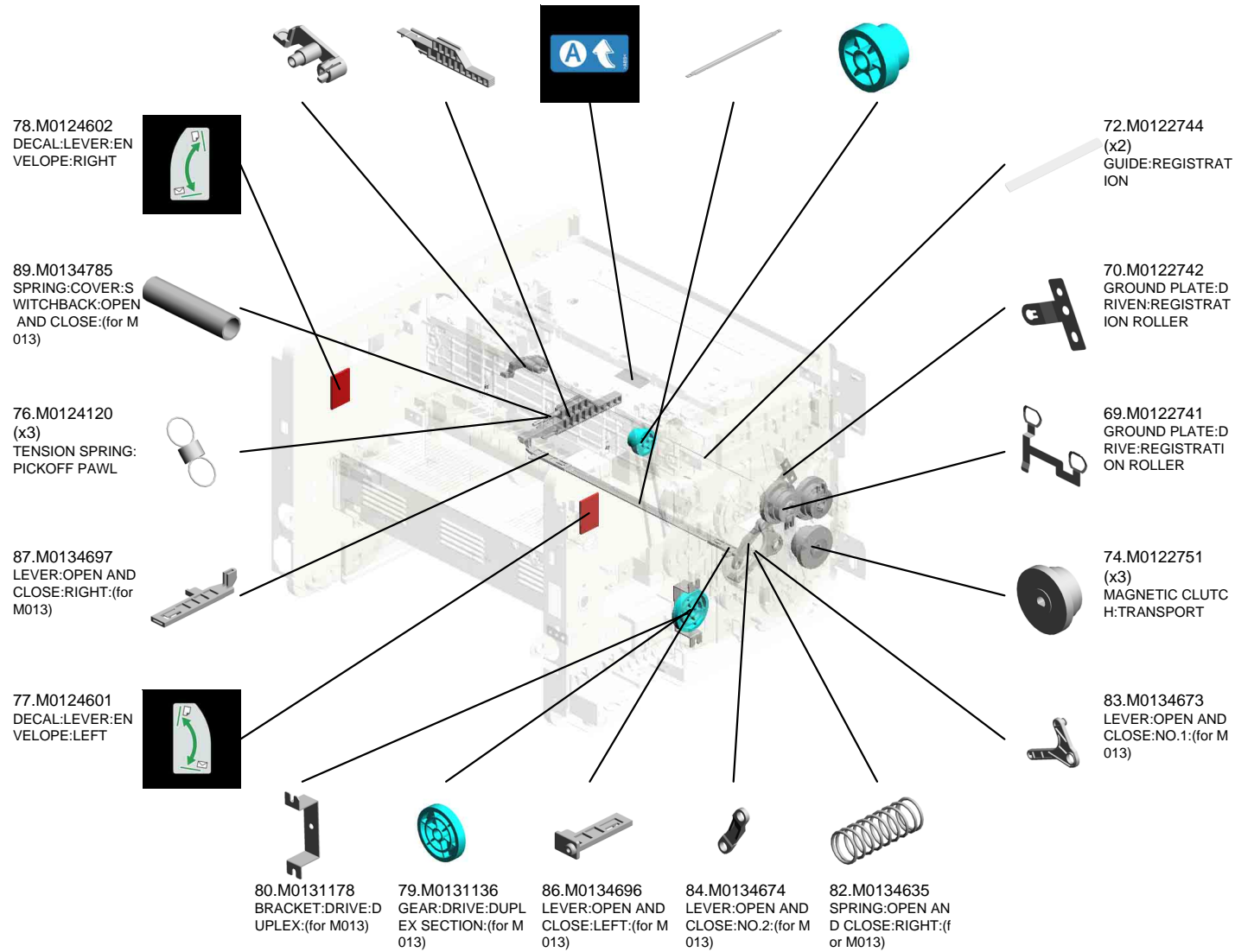
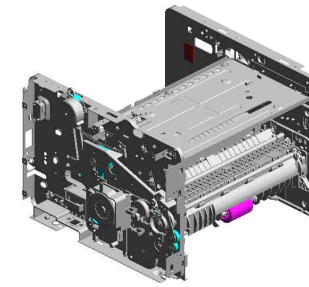

# U012 MAIN FRAME/PAPER FEED

90.M0121115  
201010-03 O/O

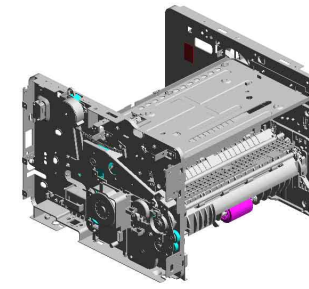

94.M1081099  
HEAT INSULATING  
PLATE:FUSING:FR  
ONT:(for M120)  
201112-01

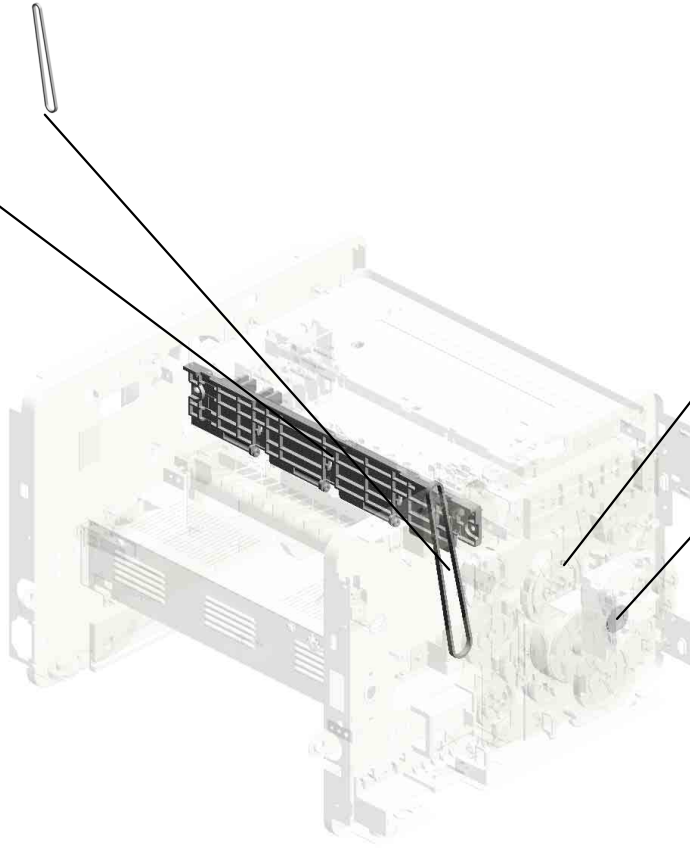

91.M0122725  
201010-01 X/O



95.M0122631  
CLOTH:EARTH:PA  
PER FEED  
201203-05



G1272575  
[A]  
BUSHING - 6X10X6  
201203-03 X/O

U012\_S001  
MAIN SWITCH:SERVICE:ASS'Y

92.12042879  
SWITCH:ABL-21-15  
N2  
201103-04 X/X

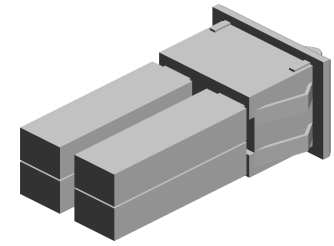
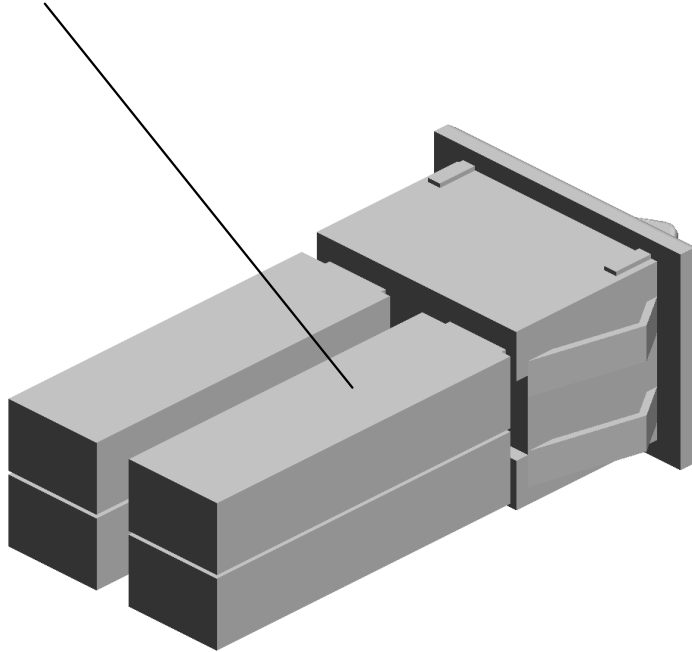
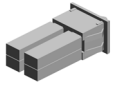

93.M0125039  
MAIN SWITCH:SER  
VICE:ASS'Y  
201103-05

U001	U002	U003	U004	U005	U006	U007	U008	U009	U010	U011	U012
------	------	------	------	------	------	------	------	------	------	------	------

U012\_S002  
JOINT UNIT:ASS'Y

73.M0122745  
GROUND PLATE:D  
RIVEN

60.M0122705  
(x2)  
SPRING:ROLLER

75.M0122753  
(x2)  
BUSHING:ROLLER:  
DRIVEN

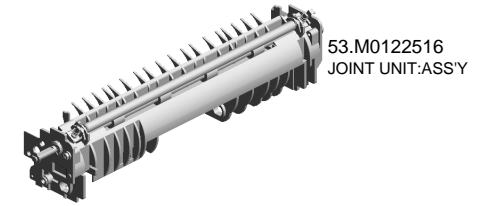

53.M0122516  
JOINT UNIT:ASS'Y

1.04503008N  
(x2)  
TAPPING SCREW -  
M3X8

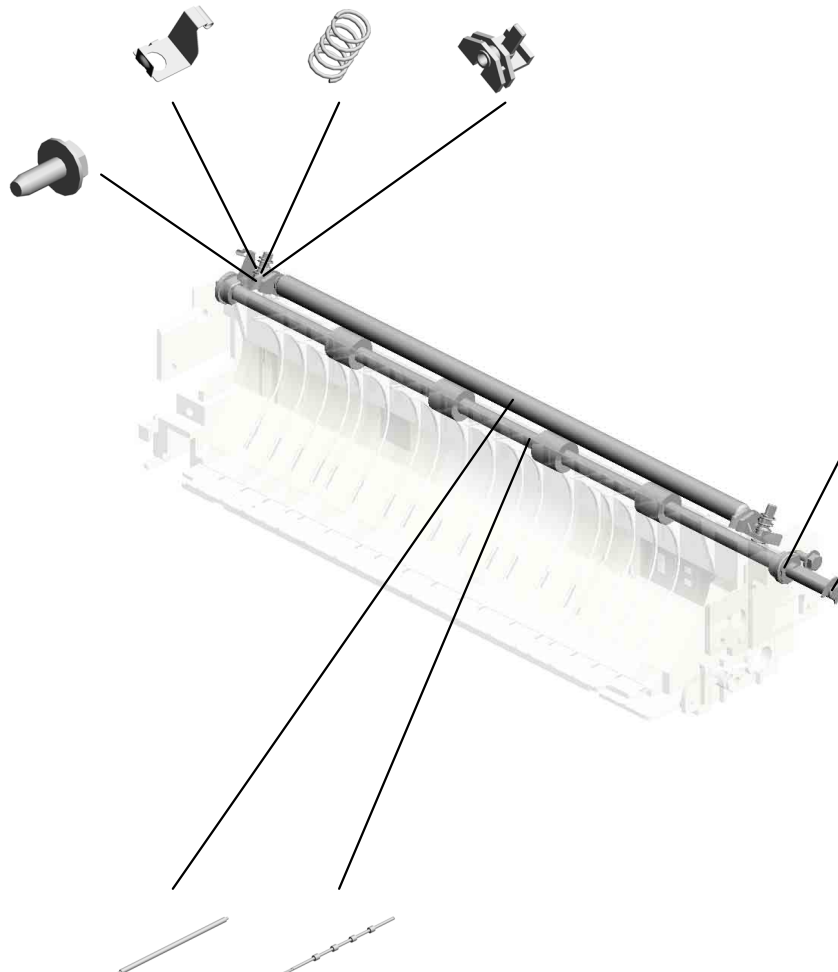

23.M0124488  
(x2)  
[A]  
BUSHING:DIA6XDI  
A10X6  
201203-03 X/O

10.08050089  
(x3)  
RETAINING RING -  
M4

G1272575  
[A]  
BUSHING - 6X10X6  
201203-03 X/O

59.M0122702  
ROLLER:INTERFA  
CE:DRIVEN

58.M0122701  
ROLLER:INTERFA  
CE:DRIVE

U001	U002	U003	U004	U005	U006	U007	U008	U009	U010	U011	U012
------	------	------	------	------	------	------	------	------	------	------	------

# ACCESSORIES



1.J0121515  
PLATE:LOGO:NSA:(for M012/M013)



2.J0121516  
PLATE:LOGO:REX:(for M012/M013)



3.J0121517  
PLATE:LOGO:GES:(for M012/M013)



4.M0120402  
MODEL NAME PLATE:(for M012)



5.M0125699  
POWER SUPPLY CORD:250V:10A:EU



6.M0127426  
MODEL NAME PLATE:REX:(for M012)



7.M0127427  
MODEL NAME PLATE:GES:(for M012)



8.M0127428  
MODEL NAME PLATE:NSA:(for M012)



9.M0130402  
MODEL NAME PLATE M013:(for M013 )



10.M0137426  
MODEL NAME PLATE:REX:(for M013)



11.M0137427  
MODEL NAME PLATE:GES:(for M013)



12.M0137428  
MODEL NAME PLATE:NSA:(for M013)



13.M1200402  
MODEL NAME PLATE:M120:(for M120 )  
201112-03

## Exclusive Parts

Number	Part Name	Group	ID
A1532117	ROLLER TERMINAL	U012	16
AA143520	SHOULDER SCREW - M3	U004	3
		U007_S001	9
AW110058	THERMOSTAT:177	U007_S001	10
AX050265	STEPPER MOTOR:DC24V 7.2W:(for M013)	U012	17
AX640199	FAN:MM80:25MM:DC 2.16W	U012	18
B2681085	SWITCH:LF-105-11	U012	19
G0123050	SIDE FENCE GEAR	U004_S001	4
G0201160	SNAP RING	U012	20
G0271180	RUBBER FOOT - GF	U012	21
G0292767	BY-PASS FEED COVER	U004	5
G0521120	SPRING - PAPER EXIT RELEASE	U012	22
G0521518	SPRING - LOCK LEVER	U001	4
G0961019	TRANSPORT GUIDE PIN:(for M013)	U008	2
G1022717	COVER:DC SOLENOID	U004	6
G1022755	RACK:SIDE FENCE:REAR	U004_S001	7
G1022789	STOPPER:PHOTOINTERRUPTOR	U004	8
G1272627	PAPER FEED ROLLER - MM32	U012	24
G1274328	DECAL - HIGH TEMPERATURE	U007_S001	11
G8003133	SIDE FENCE GEAR	U003	1
GF013001	BOTTOM PLATE PAD	U003_S001	2
		U004_S001	9
GW010007	PHOTO REFLECTION SENSOR:EXIT	U012	25
GW020020	PHOTOINTERRUPTOR:LG248NL1	U004	10
		U007_S001	12
		U008	3
		U009	4
		U012	26
J0121508	PLATE:LOGO:RIC	U001	5
J0121515	PLATE:LOGO:NSA:(for M012/M013)	ACCESSORIES	1
J0121516	PLATE:LOGO:REX:(for M012/M013)	ACCESSORIES	2
J0121517	PLATE:LOGO:GES:(for M012/M013)	ACCESSORIES	3
M0120050	OPERATION PANEL:ASS'Y	U001_S002	6
M0120402	MODEL NAME PLATE:(for M012)	ACCESSORIES	4
M0121037	TONER BOTTLE:CASE	U012	27
M0121040	CASE:DISCHARGE LAMP	U012	28

Number	Part Name	Group	ID
M0121046	DUCT:HARNESS	U012	29
M0121050	FRAME:MAIN:SUB-ASS'Y:(for M013)	U012	30
M0121063	TERMINAL:CHARGE	U012	31
M0121065	CASE:TERMINAL	U012	32
M0121066	SPRING:TERMINAL:CHARGE	U012	33
M0121088	COIL SPRING:RAIL:RIGHT	U012	34
M0121089	GUIDE:PAPER:LEADING EDGE	U012	35
M0121097	SUPPORTER:PAPER:TRANSPORT	U012	36
M0121099	HEAT INSULATING PLATE:FUSING:FRONT:(for M012/M013)	U012	37
M0121115		U012	90
M0121117	GEAR:DRIVE:DRUM	U012	39
M0121118	GEAR:DRIVE:FUSING:NO.1	U012	40
M0121119	GEAR:DRIVE:FUSING:NO.2	U012	41
M0121120	GEAR:DRIVE:FUSING:NO.3	U012	42
M0121121	GEAR:DRIVE:PAPER FEED:NO.1	U012	43
M0121122	GEAR:DRIVE:PAPER FEED:NO.2	U012	44
M0121123	GEAR:DRIVE:PAPER FEED:NO.3	U012	45
M0121124	GEAR:DRIVE:PAPER FEED:NO.4	U012	46
M0121127	GEAR:DRIVE:EXIT:(for M012)	U012	47
M0121128	GEAR:DRIVE:FUSING:NO.4	U012	48
M0121150	BRUSHLESS MOTOR:DC 36.7W	U012	49
M0121171	GEAR:DRIVE:MANUAL FEED SECTION:NO.1	U012	50
M0121172	GEAR:DRIVE:MANUAL FEED SECTION:NO.2	U012	51
M0121300	COVER:FRONT	U001	7
M0121301	BUTTON:RIGHT	U001	8
M0121302	COVER:UPPER:(for M012/M013)	U001	9
M0121311	COVER:UPPER FRONT:TRANSPARENT	U001	10
M0121324		U001	22
M0121325		U001	23
M0121330	COVER:LEFT	U001	13
M0121331	COVER:LEFT UPPER:TRANSPARENT	U001	14
M0121340	COVER:RIGHT:220V	U001	15

## Exclusive Parts

Number	Part Name	Group	ID
M0121341	COVER:RIGHT UPPER:TRANSPARENT	U001	16
M0121350	GUIDE PLATE:(for M012)	U001	17
M0121360	COVER:REAR MIDDLE	U001	18
M0121370	COVER:REAR LOWER	U001	19
M0121851	IMAGING UNIT	U002_S001	5
M0121957	POLYGON MOTOR:DC 18W	U002_S001	6
M0122056	DISCHARGE LAMP	U012	52
M0122504	PAPER TRAY	U003	3
M0122516	JOINT UNIT:ASS'Y	U012_S002	53
M0122589	PAPER TRAY:REAR	U003	4
M0122590	COIL SPRING:EARTH	U003	5
M0122603	STOPPER:BASE PLATE	U003	6
M0122604	SPRING:RELEASE:TRAY BOTTOM PLATE	U003	7
M0122605	FRICTION PAD:ADHESION	U003	8
M0122608	END FENCE	U003	9
M0122610	TRAY BOTTOM PLATE	U003_S001	10
M0122612	COMPRESSION SPRING:TRAY BOTTOM PLATE	U003	11
M0122613	COMPRESSION SPRING:SEPARATION	U003	12
M0122614	SIDE FENCE:LEFT	U003	13
M0122615	SIDE FENCE:RIGHT	U003	14
M0122616	LEVER:PAPER VOLUME SENSOR	U003	15
M0122618	DECAL:PAPER TRAY:FRONT	U003	16
M0122629	COVER:PAPER TRAY	U003	17
M0122630	DECAL:PICK-UP PAPER JAM:(for M012)	U001	20
<b>M0122631</b>	<b>CLOTH:EARTH:PAPER FEED</b>	<b>U012</b>	<b>95</b>
M0122668	SHAFT:PAPER FEED:ASS'Y	U012	54
M0122671	FEELER:PAPER END SENSOR	U012	55
M0122672	RAIL:PAPER TRAY:LEFT	U012	56
M0122673	RAIL:PAPER TRAY:RIGHT	U012	57
M0122701	ROLLER:INTERFACE:DRIVE	U012_S002	58
M0122702	ROLLER:INTERFACE:DRIVEN	U012_S002	59
M0122705	SPRING:ROLLER	U012_S002	60
M0122711	BUSHING:REGISTRATION:DRIVEN	U012	61

Number	Part Name	Group	ID
	:LEFT		
M0122715	GUIDE PLATE:TRANSPORT:UPPER	U012	62
M0122717	REGISTRATION ROLLER:DRIVE	U012	63
M0122719	REGISTRATION ROLLER:DRIVEN	U012	64
M0122722	SPRING:ROLLER:REGISTRATION	U012	65
M0122723	FEELER:REGISTRATION:SENSOR	U012	66
M0122725		U012	91
M0122730	BUSHING:REGISTRATION:DRIVEN:RIGHT	U012	68
M0122741	GROUND PLATE:DRIVE:REGISTRATION ROLLER	U012	69
M0122742	GROUND PLATE:DRIVEN:REGISTRATION ROLLER	U012	70
M0122743	DECAL:GUIDE PLATE:TRANSPORT:UPPER	U012	71
M0122744	GUIDE:REGISTRATION	U012	72
M0122745	GROUND PLATE:DRIVEN	U012_S002	73
M0122751	MAGNETIC CLUTCH:TRANSPORT	U012	74
M0122753	BUSHING:ROLLER:DRIVEN	U012_S002	75
M0122805	GUIDE PLATE:MANUAL FEED:LOWER	U004	11
M0122806	SHEET:GUIDE:MANUAL FEED SUB-UNIT	U004	12
M0122815	DECAL:FEED PAPER AGAIN:PREVENTION	U004	13
M0122816	FRICTION PAD:HOLDER:MANUAL FEED:ASS'Y	U004	14
M0122824	FEELER:MANUAL FEED	U004	15
M0122830	MECHANICAL SPRING CLUTCH:MANUAL FEED	U004	16
M0122831	DC SOLENOID:9.6W:24V	U004	17
M0122833	DECAL:SIDE FENCE:MANUAL FEED	U004_S001	18
M0122859	GUIDE PLATE:UPPER:MANUAL FEED	U004	19
M0122860	PAPER FEED ROLLER:MANUAL FEED	U004	20



## Exclusive Parts

Number	Part Name	Group	ID
M0122869	MANUAL FEED TABLE:SUB-ASS'Y	U004_S001	21
M0122870	COVER:MANUAL FEED TABLE	U004	22
M0122874	COMPRESSION SPRING:MANUAL FEED	U004	23
M0122875	SIDE FENCE:MANUAL FEED:RIGHT	U004_S001	24
M0122877	SIDE FENCE:MANUAL FEED:LEFT	U004_S001	25
M0122879	EXTENSION TRAY:MANUAL FEED	U004	26
M0122880	COMPRESSION SPRING:SEPARATION	U004	27
M0124031	FUSING UNIT:220V	U007_S001	13
M0124053	GEAR:HOT ROLLER	U007_S001	14
M0124055	RADIAL BALL BEARING:35X47X7	U007_S001	15
M0124109	SPRING:FEELER:EXIT	U007_S001	16
M0124120	TENSION SPRING:PICKOFF PAWL	U007_S001	17
		U012	76
M0124121	HEATER:700W:220V	U007_S001	18
M0124135	FEELER:PAPER FEED SENSOR	U007_S001	19
M0124186	COVER:LEFT UPPER:ASS'Y	U007_S001	20
M0124202	LEVER:PRESSURE	U007_S001	21
M0124204	LEVER:LEFT:FRAME:FUSING	U007_S001	22
M0124205	LEVER:RIGHT:FRAME:FUSING	U007_S001	23
M0124206	STRIPPER PAWLS	U007_S001	24
M0124208	BRACKET:GATE PAWL	U007_S001	25
M0124211	PLATE NUT:HEATER	U007_S001	26
M0124212	FUSING ENTRANCE GUIDE PLATE:UPPER	U007_S001	27
M0124213	BUSHING:PRESSURE ROLLER	U007_S001	28
M0124215	GUIDE PLATE:EXIT	U007_S001	29
M0124216	TENSION SPRING:FUSING:GUIDE PLATE	U007_S001	30
M0124217	FUSING ENTRANCE GUIDE PLATE:LOWER	U007_S001	31
M0124220	HOT ROLLER	U007_S001	32
M0124223	THERMAL INSULATING BUSHING:HOT ROLLER	U007_S001	33
M0124229	TENSION SPRING:FUSING:PRESSURE	U007_S001	34

Number	Part Name	Group	ID
M0124234	HOUSING:THERMOSTAT:ASS'Y	U007_S001	35
M0124253	PRESSURE ROLLER:DIA30	U007_S001	36
M0124263	THERMISTOR:FUSING	U007_S001	37
M0124266	COVER:RIGHT LOWER:FUSING	U007_S001	38
M0124270	THERMAL INSULATING BUSHING:FUSING UNIT	U007	39
M0124276	COVER:LEFT:LOWER:FUSING	U007_S001	40
M0124279	CLEANING ROLLER:ASS'Y	U007_S001	41
M0124281	RETAINING RINGS-C:HOT ROLLER	U007_S001	42
M0124284	LEVER:PRESSURE:LEFT	U007_S001	43
M0124285	LEVER:PRESSURE:RIGHT	U007_S001	44
M0124287	COVER:RIGHT UPPER:FUSING	U007_S001	45
M0124292	FUSING COVER:UPPER	U007_S001	46
M0124293	EXIT ROLLER:EXIT:FUSING	U007_S001	47
M0124295	GROUND PLATE:ASS'Y	U007_S001	48
M0124453	EXIT ROLLER	U010	4
M0124454	SPRING:EXIT ROLLER:EXIT	U010	5
M0124457	GROUND PLATE:EXIT:DISCHARGE BRUSH	U010	6
M0124458	DISCHARGE BRUSH:EXIT:ASS'Y DRAWING	U010	7
M0124465	PULLEY:EXIT:(for M012)	U010	8
M0124470	EXIT ROLLER:ASS'Y:(for M012)	U010	9
M0124481	PLATE:LEFT:EXIT	U010	10
M0124482	PLATE:RIGHT:EXIT	U010	11
<b>M0124488</b>	<b>BUSHING:DIA6XDIA10X6</b>	<b>U009</b>	<b>3</b>
		<b>U010</b>	<b>3</b>
		<b>U012</b>	<b>23</b>
		<b>U012_S002</b>	<b>23</b>
M0124499	GROUND PLATE:EXIT ROLLER	U010	12
M0124601	DECAL:LEVER:ENVELOPE:LEFT	U012	77
M0124602	DECAL:LEVER:ENVELOPE:RIGHT	U012	78
M0124603	DECAL:GUIDE PLATE:B	U007_S001	49
M0124699	DECAL:WARNING (HIGH TEMPERATURE):FRONT	U007	50
<b>M0125021</b>	<b>POWER SUPPLY UNIT:EU/AA/CHN</b>	<b>U011</b>	<b>12</b>
M0125039	MAIN SWITCH:SERVICE:ASS'Y	U012_S001	93

## Exclusive Parts

Number	Part Name	Group	ID
M0125103	PCB:CTL-P:ASS'Y:(for M012/M013)	U011	4
<b>M0125455</b>	<b>PCB:ECB:(for M012)</b>	<b>U011</b>	<b>11</b>
M0125699	POWER SUPPLY CORD:250V:10A:EU	ACCESSORIES	5
M0126250	TRANSFER ROLLER:ASS'Y	U006	1
M0126252	BUSHING:TRANSFER ROLLER:RIGHT	U006	2
M0126253	BUSHING:TRANSFER ROLLER:LEFT	U006	3
M0126254	SPRING:TRANSFER ROLLER	U006	4
M0126255	GEAR:TRANSFER ROLLER	U006	5
M0126256	ROLLER:POSITIONING:TRANSFER ROLLER	U006	6
M0126259	ELECTRODE PLATE:SEPARATION	U006	7
M0126260	COVER:ELECTRODE PLATE	U006	8
M0127426	MODEL NAME PLATE:REX:(for M012)	ACCESSORIES	6
M0127427	MODEL NAME PLATE:GES:(for M012)	ACCESSORIES	7
M0127428	MODEL NAME PLATE:NSA:(for M012)	ACCESSORIES	8
M0130402	MODEL NAME PLATE M013:(for M013)	ACCESSORIES	9
M0131136	GEAR:DRIVE:DUPLEX SECTION:(for M013)	U012	79
M0131178	BRACKET:DRIVE:DUPLEX:(for M013)	U012	80
M0132630	DECAL:PICK-UP PAPER JAM:(for M013)	U001	21
M0134455	GEAR:DRIVE:EXIT ROLLER:(for M013)	U010	13
M0134470	EXIT ROLLER:DUPLEX:(for M013)	U010	14
M0134610	GEAR:DRIVE:DUPLEX:(for M013)	U012	81
M0134622	EXIT ROLLER:DUPLEX:(for M013)	U009	5
M0134623	SPRING:EXIT:(for M013)	U009	6
M0134624	SPRING:EXIT:NO.2:(for M013)	U009	7
M0134635	SPRING:OPEN AND CLOSE:RIGHT:(for M013)	U012	82

Number	Part Name	Group	ID
M0134661	STOPPER:TRANSPORT SUB-UNIT:DUPLEX	U008	13
M0134662	COVER:SWITCHBACK:OPEN AND CLOSE	U008	4
M0134663	GUIDE PLATE:VERTICAL TRANSPORT:LOWER:(for M013)	U008	5
M0134664	GUIDE PLATE:VERTICAL TRANSPORT:UPPER:(for M013)	U008	6
M0134666	SHAFT:COVER:SWITCHBACK:OPEN AND CLOSE	U008	7
M0134667	SPRING:COVER:SWITCHBACK:OPEN AND CLOSE	U008	8
M0134668	SHEET:GUIDE:HORIZONTAL TRANSPORT:LOWER:(for M013)	U009	8
M0134669	MAGNET CATCH:ASS'Y	U008	9
M0134671	SHEET:HORIZONTAL TRANSPORT:LEFT:(for M013)	U009	9
M0134672	SHEET:HORIZONTAL TRANSPORT:RIGHT:(for M013)	U009	10
M0134673	LEVER:OPEN AND CLOSE:NO.1:(for M013)	U012	83
M0134674	LEVER:OPEN AND CLOSE:NO.2:(for M013)	U012	84
M0134684	SHEET:DUPLEX:(for M013)	U008	10
M0134685	BUTTON:OPEN AND CLOSE:LOWER:(for M013)	U012	85
M0134687	GROUND PLATE:HORIZONTAL TRANSPORT:FRONT:(for M013)	U009	11
M0134688	GROUND PLATE:HORIZONTAL TRANSPORT:REAR:(for M013)	U009	12
M0134691	LEVER:OPEN AND CLOSE:LOWER:(for M013)	U009	13
M0134694	GUIDE:HORIZONTAL TRANSPORT:UPPER:(for M013)	U009	14
M0134695	GUIDE:HORIZONTAL TRANSPORT:LOWER:(for M013)	U009	15
M0134696	LEVER:OPEN AND CLOSE:LEFT:(for M013)	U012	86

## Exclusive Parts

Number	Part Name	Group	ID
M0134697	LEVER:OPEN AND CLOSE:RIGHT:(for M013)	U012	87
M0134698	BRACKET:OPEN AND CLOSE:LOWER:(for M013)	U012	88
M0134761	TRANSPORT ROLLER:DUPLEX:MI DDLE:(for M013)	U009	16
M0134762	TRANSPORT ROLLER:DUPLEX:EXIT:(for M013)	U009	17
M0134765	PULLEY:TRANSPORT:(for M013)	U009	18
M0134771		U009	23
M0134772		U009	24
M0134778	FEELER:SENSOR:HORIZONTAL TRANSPORT:(for M013)	U009	21
M0134785	SPRING:COVER:SWITCHBACK:OPEN AND CLOSE:(for M013)	U012	89
M0134794	DECAL:GUIDE PLATE:VERTICAL TRANSPORT:UPPER:(for M013)	U008	11
M0134795	PIN:GUIDE:UPPER:(for M013)	U009	22
M0134797	FEELER:SENSOR:VERTICAL TRANSPORT:(for M013)	U008	12
<b>M0135455</b>	<b>PCB:ECB:(for M013)</b>	<b>U011</b>	<b>7</b>
M0137426	MODEL NAME PLATE:REX:(for M013)	ACCESSORIES	10
M0137427	MODEL NAME PLATE:GES:(for M013)	ACCESSORIES	11
M0137428	MODEL NAME PLATE:NSA:(for M013)	ACCESSORIES	12
M1081099	HEAT INSULATING PLATE:FUSING:FRONT:(for M120)	U012	94
M1085455	PCB:ECB:M120:(for M120)	U011	9
M1200402	MODEL NAME PLATE:M120:(for M120)	ACCESSORIES	13
M1200408	DECAL:OPERATION SUB-UNIT:EU:(for M120)	U001_S001	24
M1201255	COVER:UPPER:EU:ASS'Y:(for M120)	U001_S001	25
M1205100	PCB:CTL:EU:ASS'Y:(for M120)	U011	10

## Standard Parts



03603006N  
SCREW - M3X6



04503008N  
TAPPING SCREW - M3X8

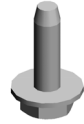

04503010N  
TAPPING SCREW - M3X10



04513006N  
TAPPING SCREW - 3X6

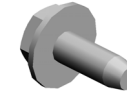

04513008N  
TAPPING SCREW - M3X8

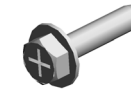

04513014N  
TAPPING SCREW:3X14



04513030N  
TAPPING SCREW:3X30



04523010N  
BINDING SELF-TAPPING SC  
REW:3X10



04533006N  
TAPPING SCREW - M3X6



04543006Q  
TAPPING SCREW - M3X6



04543008Q  
TAPPING SCREW:3X8



04543014Q  
TAPPING SCREW:3X14



07200040E  
RETAINING RING - M4



08025318  
BINDING HEAD TAPPING SC  
REW:ES:3X10



08046127  
HEXAGONAL BOLT:DOUBLE  
SCREW:M3X8



08050088  
RETAINING RING - M6



08050089  
RETAINING RING - M4



09504006N  
SCREW - M4X6



09543010N  
SCREW:POLISHED ROUND/  
SPRING:M3X10

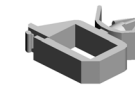

11050508  
HARNES CLAMP - LWS-071  
1

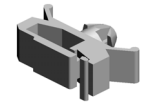

11050511  
HARNES CLAMP - LWS-030  
6ZC



11050534  
CLAMP

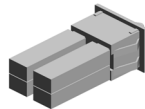

12042499  
SWITCH:AC250V/10A

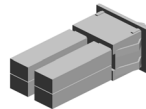

12042879  
SWITCH:A8L-21-15N2



14076657  
EEPROM:BR93L76-W



14077435

## Design Change List

Number	Title	Set	Old Part		New Part		Index No.		Q'ty	Interchg		Reason	Cut-in S/N
			P/N	Name	P/N	Name	Group	ID		Indiv.	Set		
201203-01	1203 Modification	-	M0125452	PCB:ECB:(for M0	M0125455	PCB:ECB:(for M0	U011	11	1	O/O		M0125452"M0125453"M0125455	M01327:
201203-02	1203 Modification	-	M0135452	PCB:ECB:(for M013)	M0135455	PCB:ECB:(for M013)	U011	7	1	O/O		M0135452"M0135453"M0135455	M01327:
201203-03	1203 Modification	-	G1272575	BUSHING - 6X10X6	M0124488	BUSHING:DIA6X DIA10X6	U009	3	4	X/O			
							U010	3	2				
							U012	23	4				
							U012_S002	23	2				
201203-05	1203 Modification	-			M0122631	CLOTH:EARTH:PA PER FEED	U012	95	1				M01327:
201203-06	1203 Modification	-	M0125016	POWER SUPPLY UNIT:EU	M0125021	POWER SUPPLY UNIT:EU/AA/CH N	U011	12	1	O/O			M01327:
201112-01	1112 Modification	-			M1081099	HEAT INSULATING PLATE:FUSING:FRONT:(for M120)	U012	94	1				M01327:
201112-02	1112 Modification	-			M1085455	PCB:ECB:M120:(for M120)	U011	9	1				M01327:
201112-03	1112 Modification	-			M1200402	MODEL NAME PLATE:M120:(for M120)	ACCESSORIES	13	1				M01327:
201112-04	1112 Modification	-			M1200408	DECAL:OPERATION SUB-UNIT:EU:(for M120)	U001_S001	24	1				M01327:
201112-05	1112 Modification	-			M1201255	COVER:UPPER:EU:ASS'Y:(for M120)	U001_S001	25	1				M01327:
201112-06	1112 Modification	-			M1205100	PCB:CTL:EU:ASS'Y:(for M120)	U011	10	1				M01327:

## Design Change List

Number	Title	Set	Old Part		New Part		Index No.		Q'ty	Interchg		Reason	Cut-in S/N
			P/N	Name	P/N	Name	Group	ID		Indiv.	Set		
201106-01	1106 Modification	-	M0125451	PCB:ECB:(for M012)	M0125452	PCB:ECB:(for M012)	U011	8	1	O/O			M01327:
201106-03	1106 Modification	-	M0125100	PCB:CTL-P:ASS'Y	M0125103	PCB:CTL-P:ASS'Y:(for M012/M013)	U011	4	1	X/O		M0125100"M0125102"M0125103	M01327:
201106-04	1106 Modification	-			M0134661	STOPPER:TRANSPORT SUB-UNIT:DUPLEX	U008	13	1				M01327:
201103-01	1103 Modification	-	M0135451	PCB:ECB:(for M013)	M0135452	PCB:ECB:(for M013)	U011	7	1	O/O			M01327:
201103-02	1103 Modification	A	M0125689	HARNESS:MAIN SWITCH:EU	M0125684	HARNESS:MAIN SWITCH:EU				X/X	O/O		M01327:
201103-03	1103 Modification	A	M0125690	HARNESS:INLET:EU	M0125685	HARNESS:INLET:EU				X/X	O/O		M01327:
201103-04	1103 Modification	A	12042499	SWITCH:AC250V/10A	12042879	SWITCH:A8L-21-15N2	U012_S001	92	1	X/X	O/O		M01327:
201103-05	1103 Modification	A			M0125039	MAIN SWITCH:SERVICE:ASS'Y	U012_S001	93	1		O/O		M01327:
201010-01	1010 Modification	-	M0122724	SPRING:FEELER:REGISTRATION	M0122725		U012	91	1	X/O			M01327:
201010-02	1010 Modification	-	M0121321	EXTENSION TRAY:GUIDE	M0121324		U001	22	1	X/O			M01327:
201010-03	1010 Modification	-	M0121114	TIMING BELT:DRIVE:EXIT:(for M012)	M0121115		U012	90	1	O/O			M01327:
201010-04	1010 Modification	-	M0134766	TIMING BELT:HORIZONTAL TRANSPORT:(for M013)	M0134771		U009	23	1	O/O			M01327:
201010-05	1010 Modification	-	M0134770	TIMING BELT:DR	M0134772		U009	24	1	O/O			M01327:

## Design Change List

Number	Title	Set	Old Part		New Part		Index No.		Q'ty	Interchg		Reason	Cut-in S/N
			P/N	Name	P/N	Name	Group	ID		Indiv.	Set		
		-		IVE:(for M013)									
201010-06	1010 Modification	-	M0121320	EXTENSION TRAY:EXIT	M0121325		U001	23	1	X/O			M01327:
201010-07	1010 Modification	-	14076657	EEPROM:BR93L76-W	14077435		U011	6	1	O/O			M01327:

