

**Digital Copier**  
**(M147/M165-EU/AA)**  
**Parts Catalog**

Model	Product Code	PC Style
Digital Copier	M142/M143/144 M145/M147/M148/M149/M150 M162/M163/M165/M166/M167/M168	3D

# Unit All



U001  
EXTERIOR

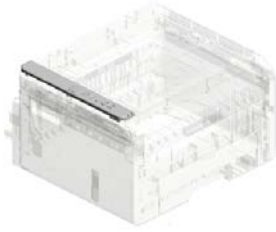

U002  
OPERATION



U003  
SCANNER

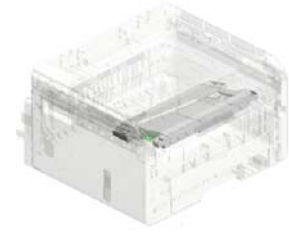

U004  
LASER UNIT

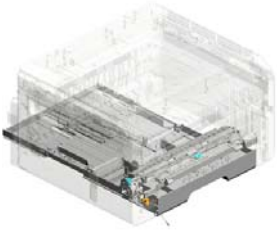

U005  
PAPER FEED

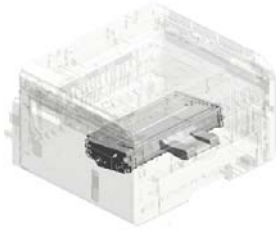

U006  
PCU

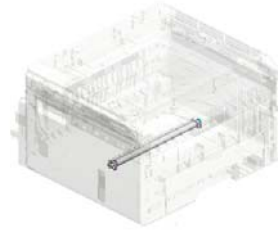

U007  
TRANSFER/SEPARATION

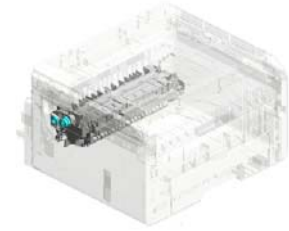

U008  
FUSING

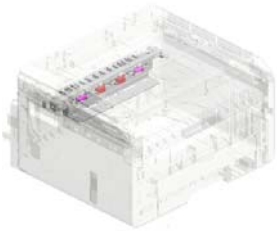

U009  
PAPER EXIT

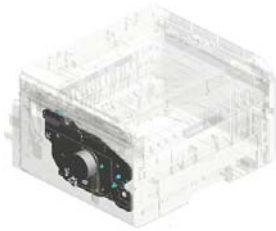

U010  
MAIN DRIVE

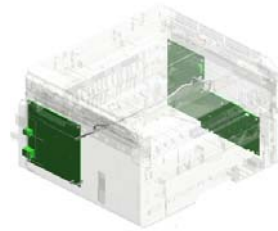

U011  
ELECTRICAL

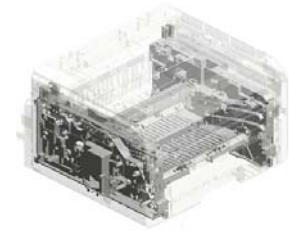

U012  
MAIN FRAME

# U001 EXTERIOR

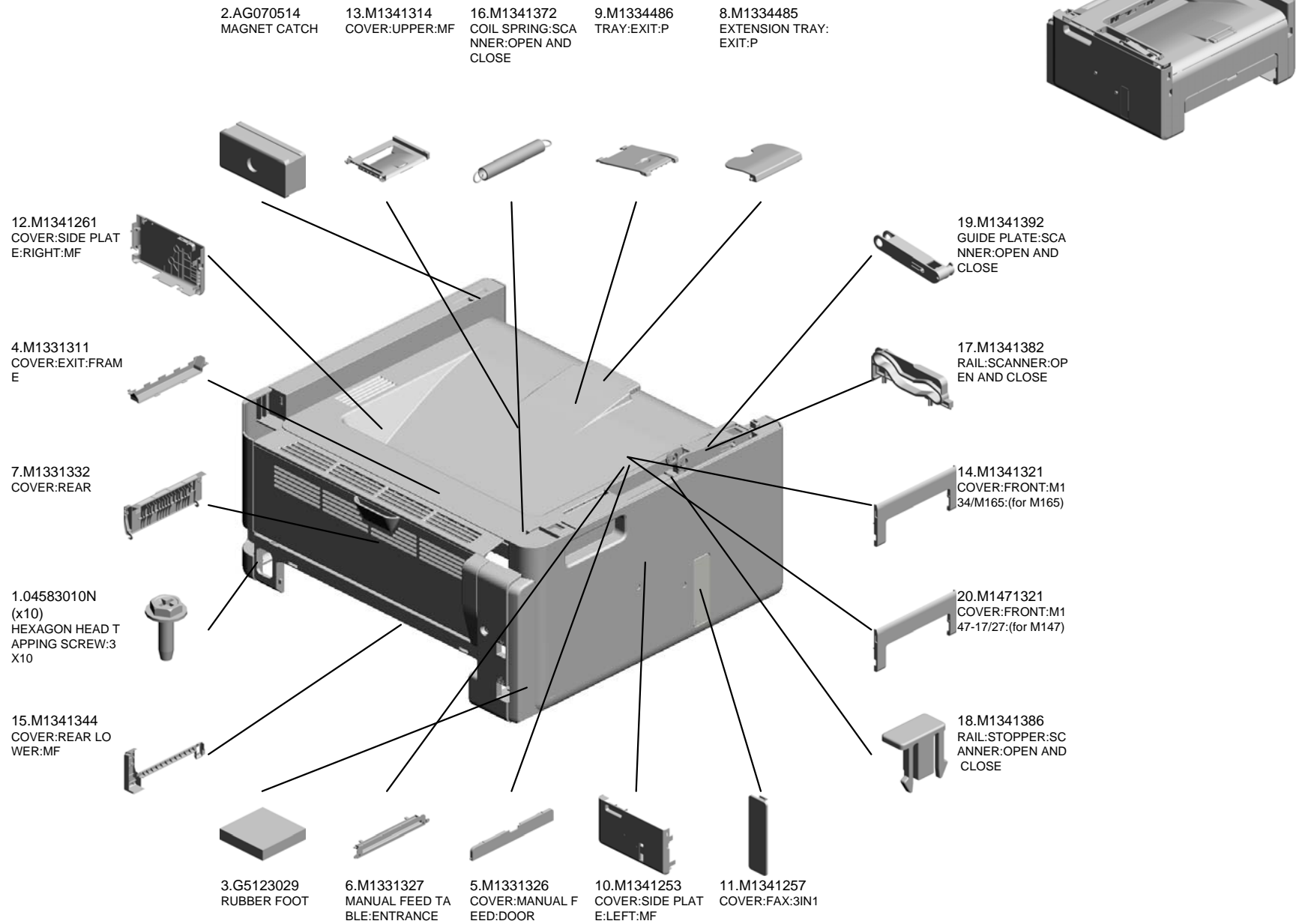

# U002 OPERATION

1.M1470051  
OPERATION PANE  
L:ASS'Y:EU/AP:M14  
7/M165

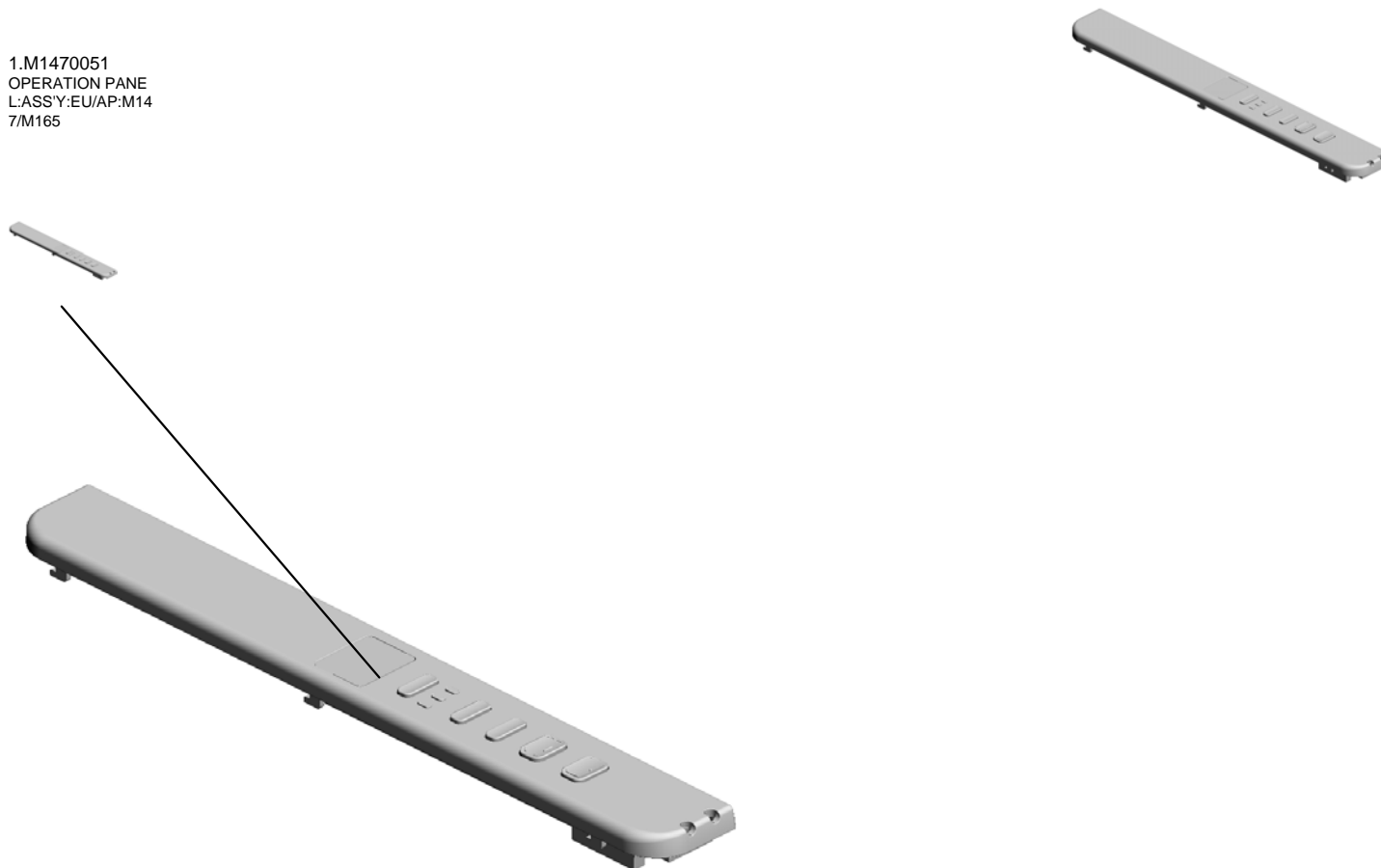

U003  
SCANNER

1.M1341600  
SCANNER:ASSY

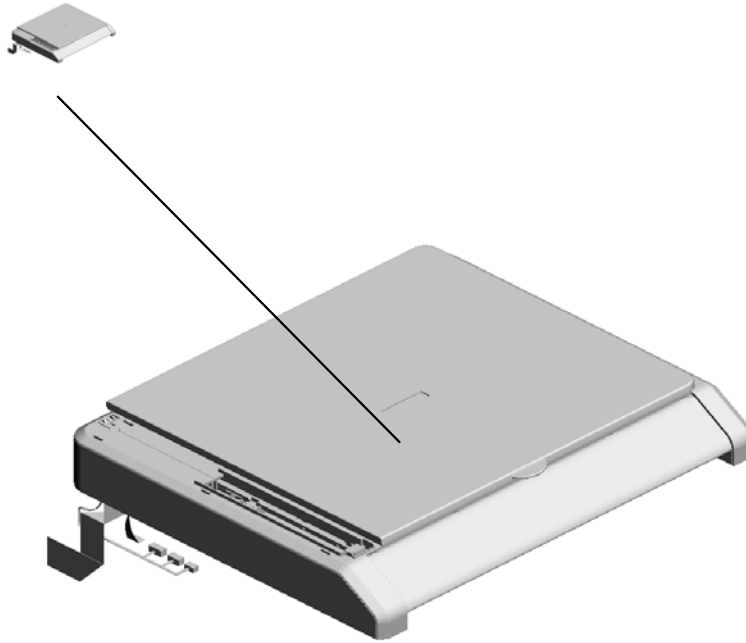

U001	U002	U003	U004	U005	U006	U007	U008	U009	U010	U011	U012
------	------	------	------	------	------	------	------	------	------	------	------

# U004.LASER UNIT

U004\_S001  
M1331850  
OPTICAL WRITING UNIT

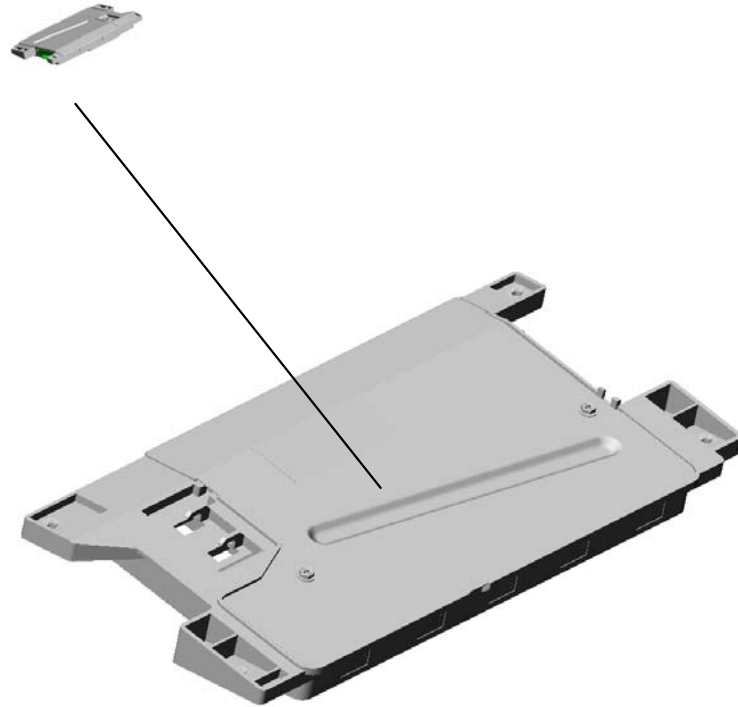

U001	U002	U003	U004	U005	U006	U007	U008	U009	U010	U011	U012
------	------	------	------	------	------	------	------	------	------	------	------

U004  
LASER UNIT

1.04583010N  
(x4)  
HEXAGON HEAD TAPPING SCREW:3  
X10



U001	U002	U003	U004	U005	U006	U007	U008	U009	U010	U011	U012
------	------	------	------	------	------	------	------	------	------	------	------



U004\_S001  
OPTICAL WRITING UNIT

1.04583010N  
(x2)  
HEXAGON HEAD TAPPING SCREW:3  
X10



2.M1331850  
OPTICAL WRITING  
UNIT

U001	U002	U003	U004	U005	U006	U007	U008	U009	U010	U011	U012
------	------	------	------	------	------	------	------	------	------	------	------

# U005.PAPER FEED

U005\_S001  
M1332501  
PAPER TRAY:ASSY

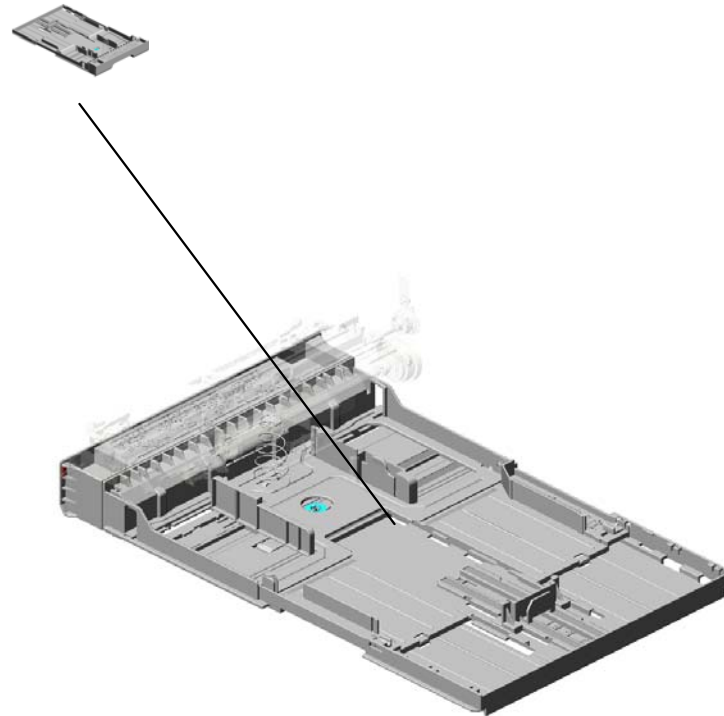

U001	U002	U003	U004	U005	U006	U007	U008	U009	U010	U011	U012
------	------	------	------	------	------	------	------	------	------	------	------

# U005\_S001.PAPER TRAY:ASS'Y

U005\_S001\_S001  
M1332610  
TRAY BOTTOM PLATE

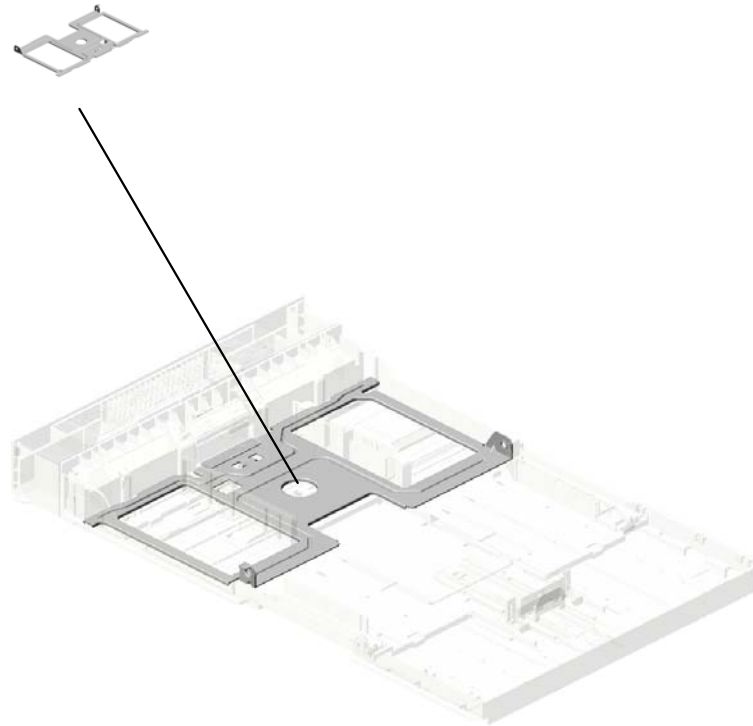

U001	U002	U003	U004	<b>U005</b>	U006	U007	U008	U009	U010	U011	U012
------	------	------	------	-------------	------	------	------	------	------	------	------

# U005 PAPER FEED

8.G8003133  
SIDE FENCE GEAR

11.M0124488  
(x2)  
BUSHING:DIA6XDI  
A10X6

7.G0201160  
(x2)  
SNAP RING

33.M1332741  
GUIDE PLATE:CON  
NECTING

34.M1332742  
TRANSPORT ROLL  
ER:CONNECTING



12.M0134622  
(x2)  
EXIT ROLLER:DUP  
LEX

4.08050089  
(x2)  
RETAINING RING -  
M4

16.M1332550  
(x2)  
BUSHING:FLANGE  
TYPE:DIA6

29.M1332732  
FEELER:PAPER E  
ND SENSOR:PAPE  
R FEED

6.AW020198  
(x3)  
PHOTOINTERRUP  
TOR:LG2A14NL1

10.M0122631  
CLOTH:EARTH:PA  
PER FEED

13.M0134623  
(x2)  
SPRING:EXIT

35.M1332743  
FEELER:REGISTR  
ATION SENSOR

31.M1332735  
FILM:PAPER FEED

32.M1332737  
SHAFT:FEED

1.04513006N  
TAPPING SCREW -  
3X6

14.M1014452  
GEAR:EXIT ROLLE  
R:PAPER EXIT UNI  
T

2.04583010N  
(x2)  
HEXAGON HEAD T  
APPING SCREW:3  
X10

3.07200040E  
RETAINING RING -  
M4

30.M1332734  
ELECTROMAGNET  
IC CLUTCH:PAPER  
FEED

# U005 PAPER FEED

36.M1332750 GUIDE PLATE:MAN  
UAL FEED:ASSY  
39.M1332754 (x2)  
RACK:SIDE FENCE  
37.M1332752 SIDE FENCE:MAN  
UAL FEED:LEFT



38.M1332753 SIDE FENCE:MAN  
UAL FEED:RIGHT

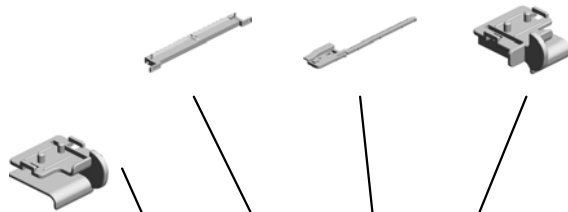

42.M1332762 GROUND PLATE:R  
OLLER:CONNECTI  
NG

40.M1332755 FEELER-MANUAL  
FEED SENSOR

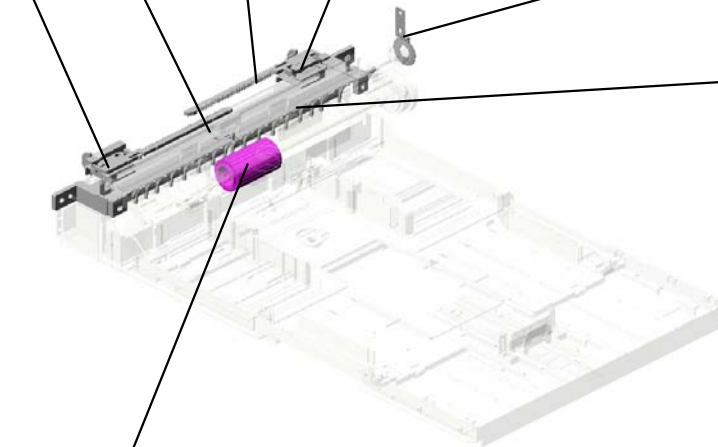

41.M1332759 PAPER FEED ROL  
LER

U005\_S001  
PAPER TRAY:ASS'Y

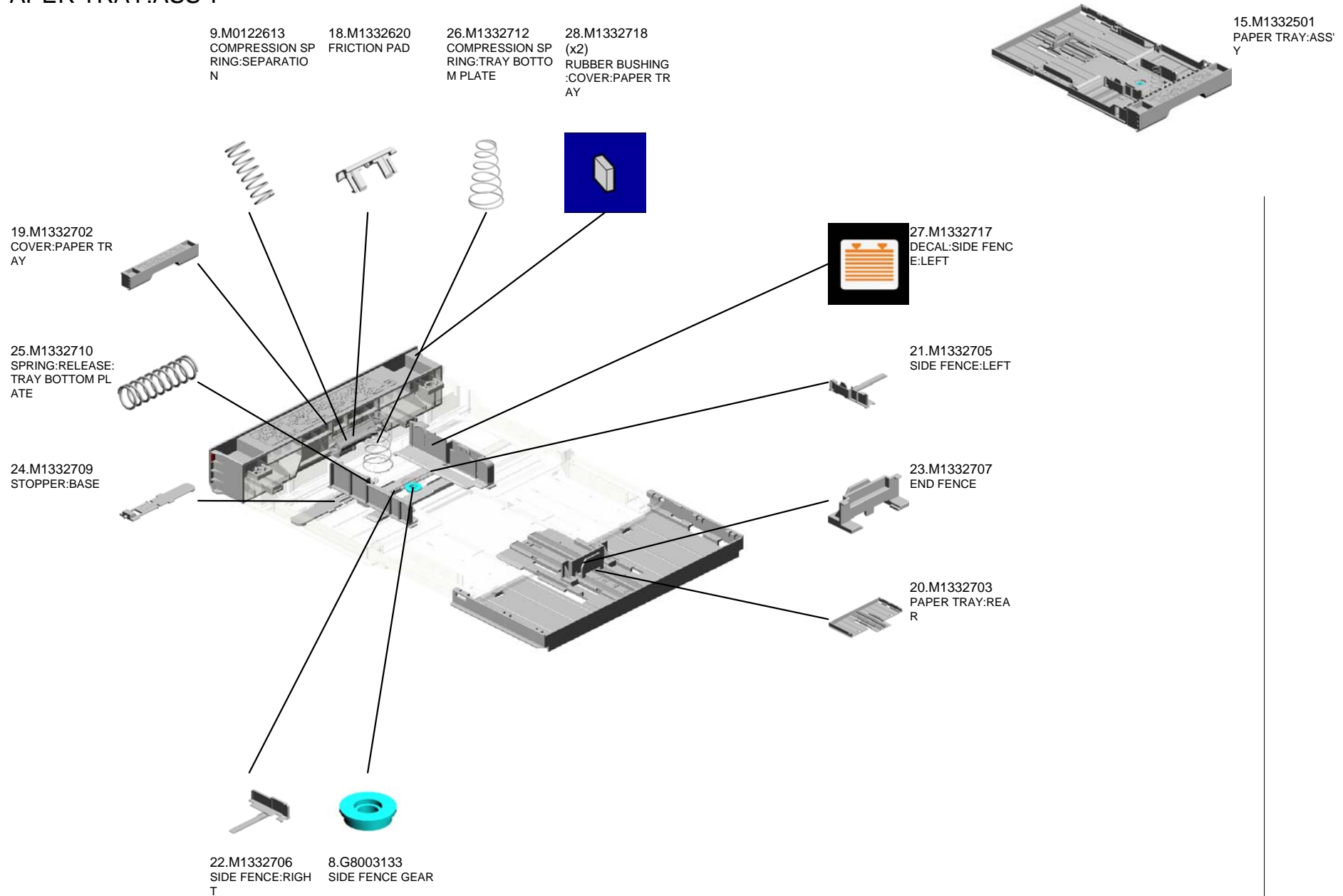

U001	U002	U003	U004	U005	U006	U007	U008	U009	U010	U011	U012
------	------	------	------	------	------	------	------	------	------	------	------

U005\_S001\_S001  
TRAY BOTTOM PLATE

5.52152713  
BOTTOM PLATE P  
AD

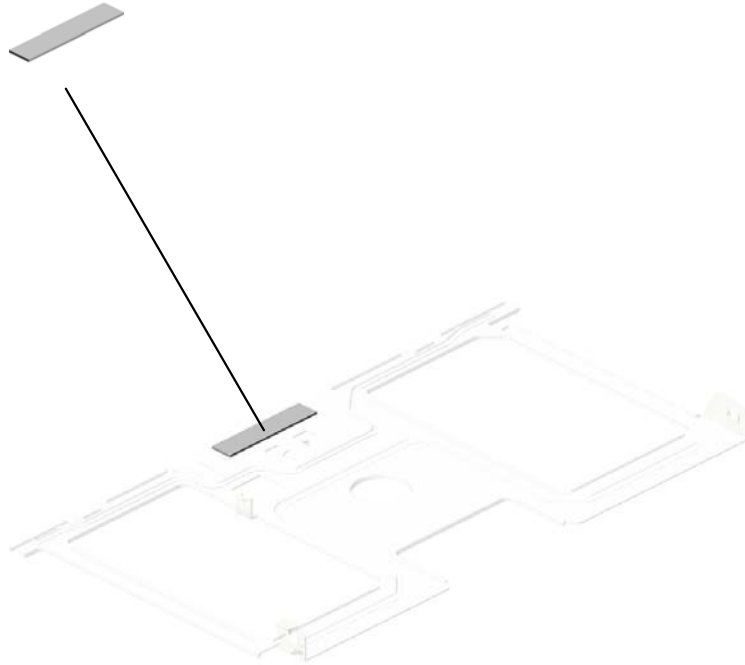

17.M1332610  
TRAY BOTTOM PL  
ATE

U001	U002	U003	U004	<b>U005</b>	U006	U007	U008	U009	U010	U011	U012
------	------	------	------	-------------	------	------	------	------	------	------	------

U006  
PCU

3.G0113941  
CAP:TONER HOPP  
ER:(for M165)

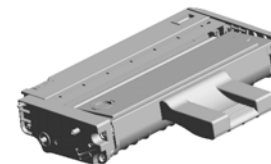

2.08050089  
RETAINING RING -  
M4



1.04583010N  
(x6)  
HEXAGON HEAD T  
APPING SCREW:3  
X10



4.M1013651  
CAP:USED TONER:  
(for M165)



U001	U002	U003	U004	U005	<b>U006</b>	U007	U008	U009	U010	U011	U012
------	------	------	------	------	-------------	------	------	------	------	------	------



# U007 TRANSFER/SEPARATION

4.M1336259  
(x2)  
ROLLER:POSITION  
ING:TRANSFER R  
OLLER

1.M1336201  
SEPARATION UNIT  
:ASS'Y

2.M1336250  
TRANSFER ROLLE  
R



5.M1336262  
BUSHING:TRANSF  
ER ROLLER:RIGHT



3.M1336254  
GEAR:TRANSFER  
ROLLER



6.M1336263  
BUSHING:TRANSF  
ER ROLLER:LEFT

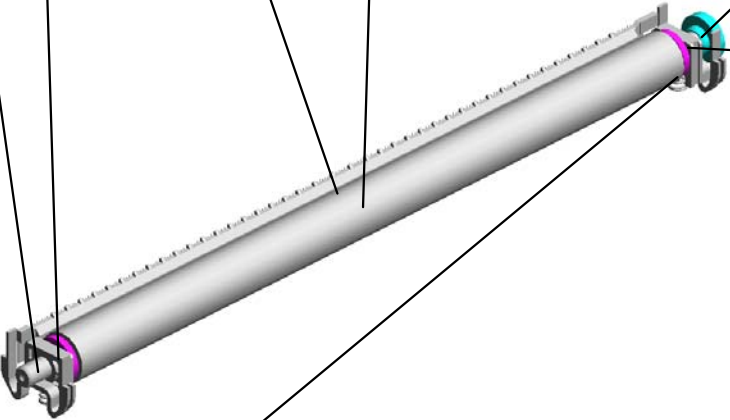

7.M1336264  
(x2)  
SPRING:TRANSFE  
R ROLLER



U001	U002	U003	U004	U005	U006	U007	U008	U009	U010	U011	U012
------	------	------	------	------	------	------	------	------	------	------	------

# U008.FUSING

U008\_S001  
M1494002  
FUSING UNIT:EU/AP:ASS'Y

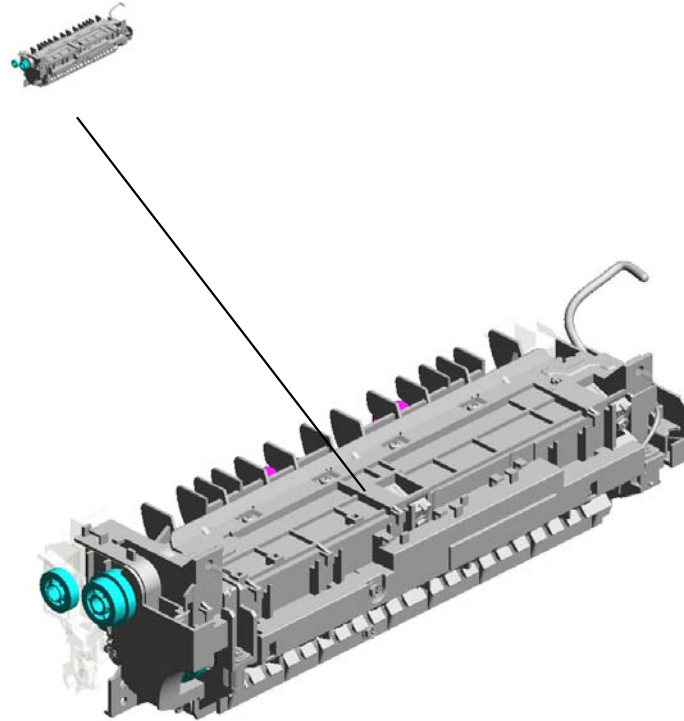

U001	U002	U003	U004	U005	U006	U007	U008	U009	U010	U011	U012
------	------	------	------	------	------	------	------	------	------	------	------

# U008 FUSING

30.M1334240 EXIT ROLLER:STR  
AIGHT

20.M1334220 COIL SPRING:FEE  
LER:EXIT

16.M1334216 GUIDE PLATE:STR  
AIGHT

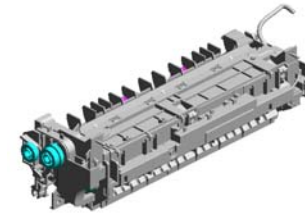

36.M1334254  
DECAL:WARNING (←  
HIGH TEMPERATU  
RE):REAR RART



2.04503014N  
(x2)  
TAPPING SCREW:  
M3X14

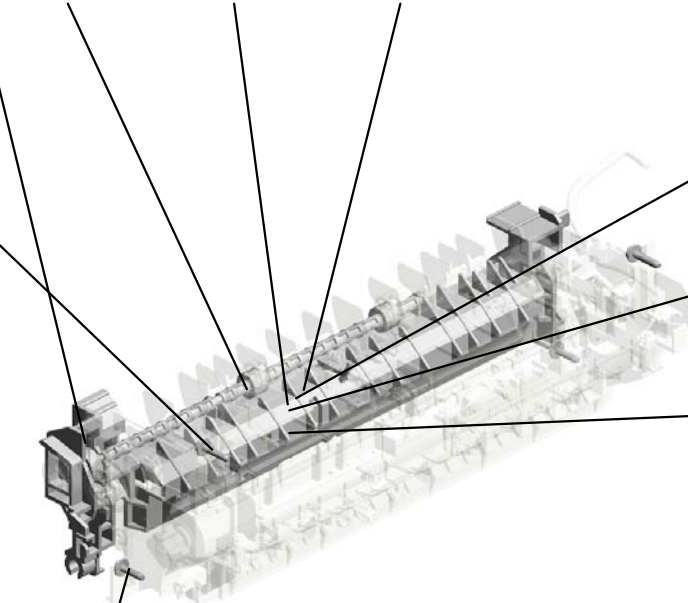
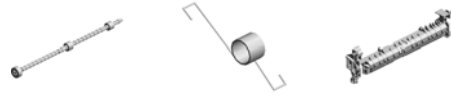

19.M1334219  
FEELER:EXIT:SEN  
SOR



26.M1334228  
COVER:FEELER



7.AW020198  
PHOTOINTERRUP  
TOR:LG2A14NL1



5.04583012N  
(x2)  
HEXAGON HEAD T  
APPING SCREW:3  
X12



U001	U002	U003	U004	U005	U006	U007	U008	U009	U010	U011	U012
------	------	------	------	------	------	------	------	------	------	------	------

U008\_S001  
FUSING UNIT:EU/AP:ASS'Y

3.04523014N (x4) BINDING SELF-TAPPING SCREW:M3 X14  
 15.M1334208 (x2) PLAIN SHAFT BEARING RING:HOT ROLLER  
 22.M1334223 (x3) TENSION SPRING: PICKOFF PAWL  
 21.M1334221 (x3) STRIPPER PAWLS  
 9.M1014203 HOT ROLLER

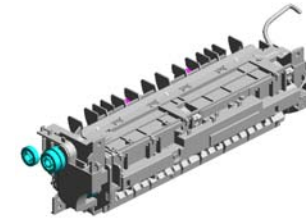

46.M1494002  
FUSING UNIT:EU/AP:ASS'Y

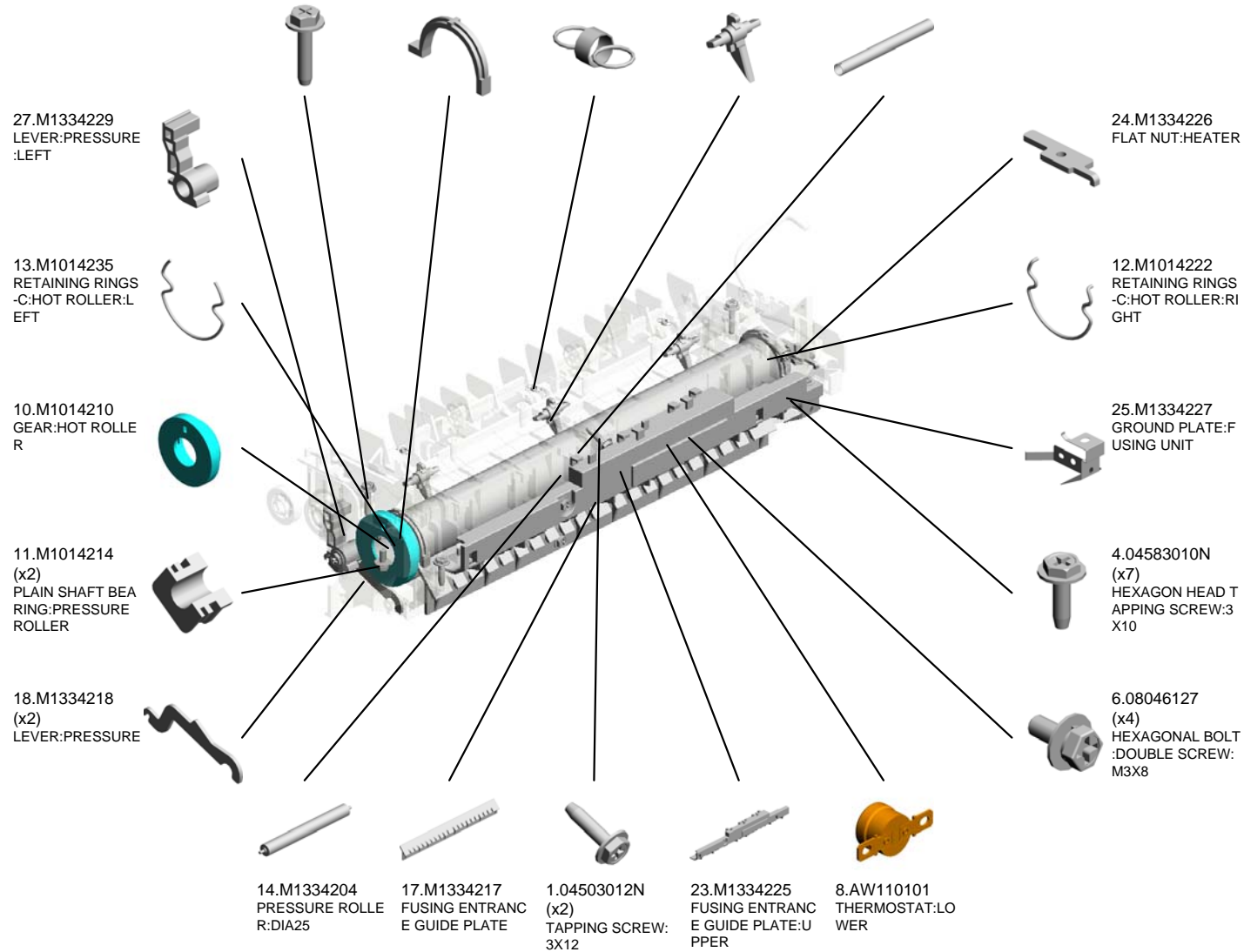

U008\_S001  
FUSING UNIT:EU/AP:ASS'Y

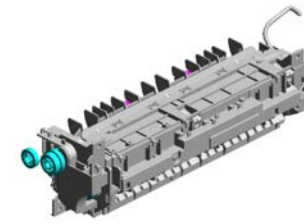

46.M1494002  
FUSING UNIT:EU/A  
P:ASSY

41.M1334263 SHEET:HOOK:LEFT  
39.M1334261 HOOK:PRESSURE:LEFT  
32.M1334243 (x2) EXIT ROLLER:FUSING  
34.M1334245 (x2) SPRING:EXIT ROLLER:FUSING

38.M1334258 GEAR:CONNECTING:STRAIGHT

43.M1334265 SHEET:PRESSURE RELEASE:LEFT

37.M1334257 GEAR:DRIVE:STRAIGHT

29.M1334231 (x2) TENSION SPRING:FUSING:PRESSURE

33.M1334244 ELECTRODE:LEFT  
45.M1454212 HEATER:700W:230V  
31.M1334241 HOUSING:THERMOSTAT  
35.M1334248 THERMISTOR

44.M1334266 SHEET:PRESSURE RELEASE:RIGHT

42.M1334264 SHEET:HOOK:RIGHT

40.M1334262 HOOK:PRESSURE:RIGHT

28.M1334230 LEVER:PRESSURE:RIGHT

# U009 PAPER EXIT

5.M1334457  
(x2)  
EXIT ROLLER

9.M1334467  
GUIDE PLATE:EXIT  
:LOWER

3.M1334451  
EXIT ROLLER:PAP  
ER EXIT UNIT

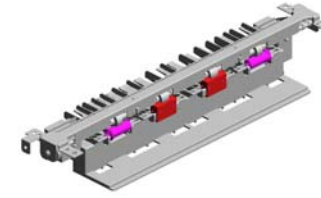

6.M1334459  
(x2)  
EXIT ROLLER

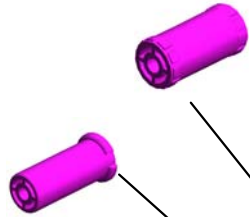

8.M1334466  
GUIDE PLATE:EXIT  
:UPPER



7.M1334465  
(x2)  
PLATE:EXIT

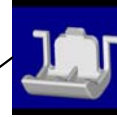

4.M1334453  
(x2)  
PLAIN SHAFT BEA  
RING:EXIT



1.04513008N  
(x2)  
TAPPING SCREW -  
M3X8



2.M0124454  
(x4)  
SPRING:EXIT ROL  
LER:EXIT



U001 U002 U003 U004 U005 U006 U007 U008 **U009** U010 U011 U012

# U010 MAIN DRIVE

1.03530030N  
(x3)  
SCREW:M3X3

5.M1331118  
GEAR:DRIVE:FUSI  
NG:NO.1

6.M1331119  
GEAR:DRIVE:FUSI  
NG:NO.2

2.04583010N  
(x5)  
HEXAGON HEAD T  
APPING SCREW:3  
X10

10.M1331127  
GEAR:DRIVE:EXIT:  
NO.2



15.M1331155  
DC BRUSHLESS M  
OTOR:20W

11.M1331131  
GEAR:DRIVE:PAPE  
R FEED:NO.1

12.M1331132  
GEAR:DRIVE:PAPE  
R FEED:NO.2

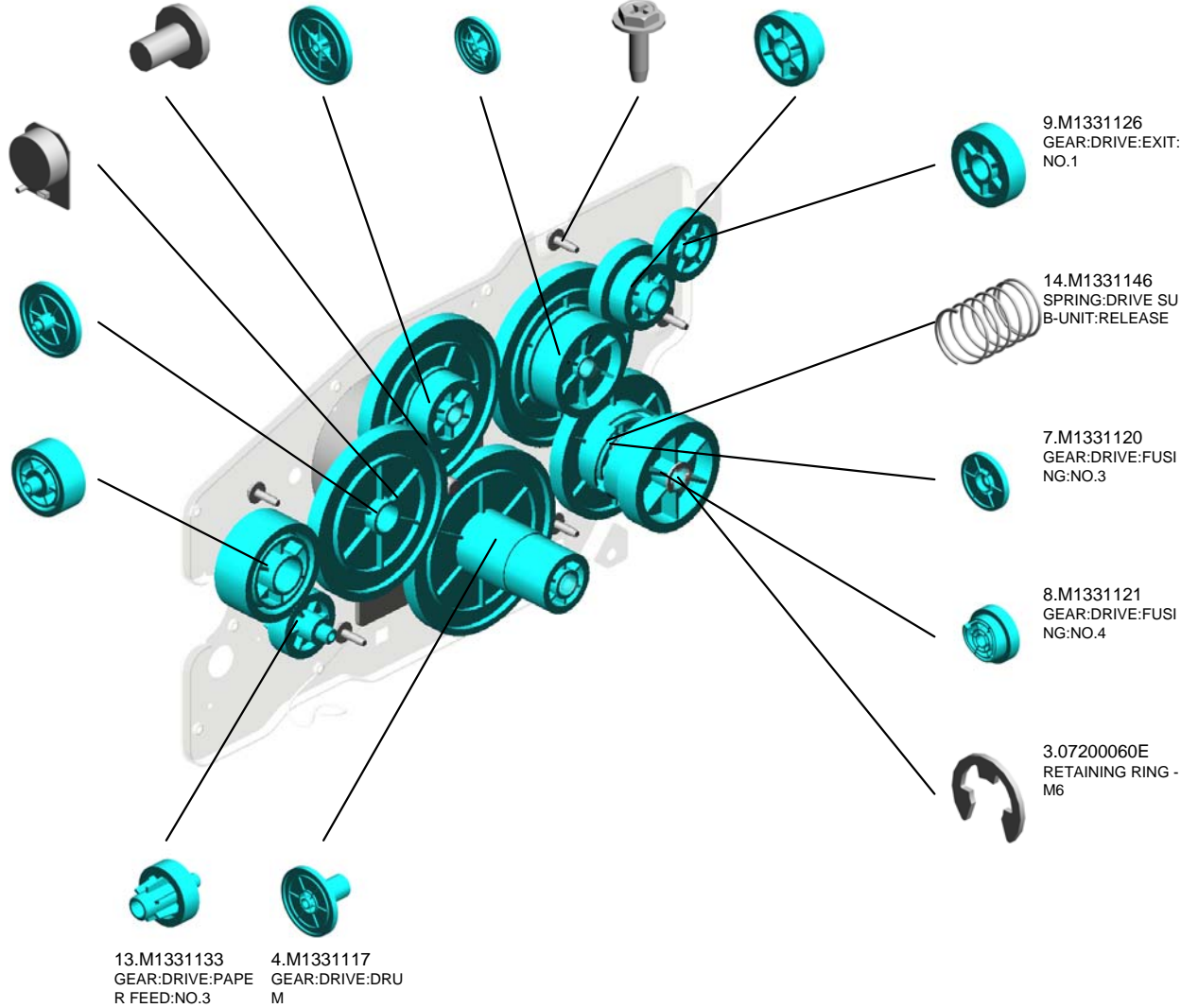

13.M1331133  
GEAR:DRIVE:PAPE  
R FEED:NO.3

4.M1331117  
GEAR:DRIVE:DRU  
M

9.M1331126  
GEAR:DRIVE:EXIT:  
NO.1

14.M1331146  
SPRING:DRIVE SU  
B-UNIT:RELEASE

7.M1331120  
GEAR:DRIVE:FUSI  
NG:NO.3

8.M1331121  
GEAR:DRIVE:FUSI  
NG:NO.4

3.07200060E  
RETAINING RING -  
M6

# U011 ELECTRICAL

1.04513006N  
(x8)  
TAPPING SCREW -  
3X6

3.M1335313  
POWER SUPPLY U  
NIT:60.09W:EU:AS  
SY

5.M1475050  
PCB:ECBCTL:WW:  
ASS'Y:M147/M165

2.04583010N  
(x2)  
HEXAGON HEAD T  
APPING SCREW:3  
X10

4.M1335402  
POWER PACK:CH  
N:ASS'Y

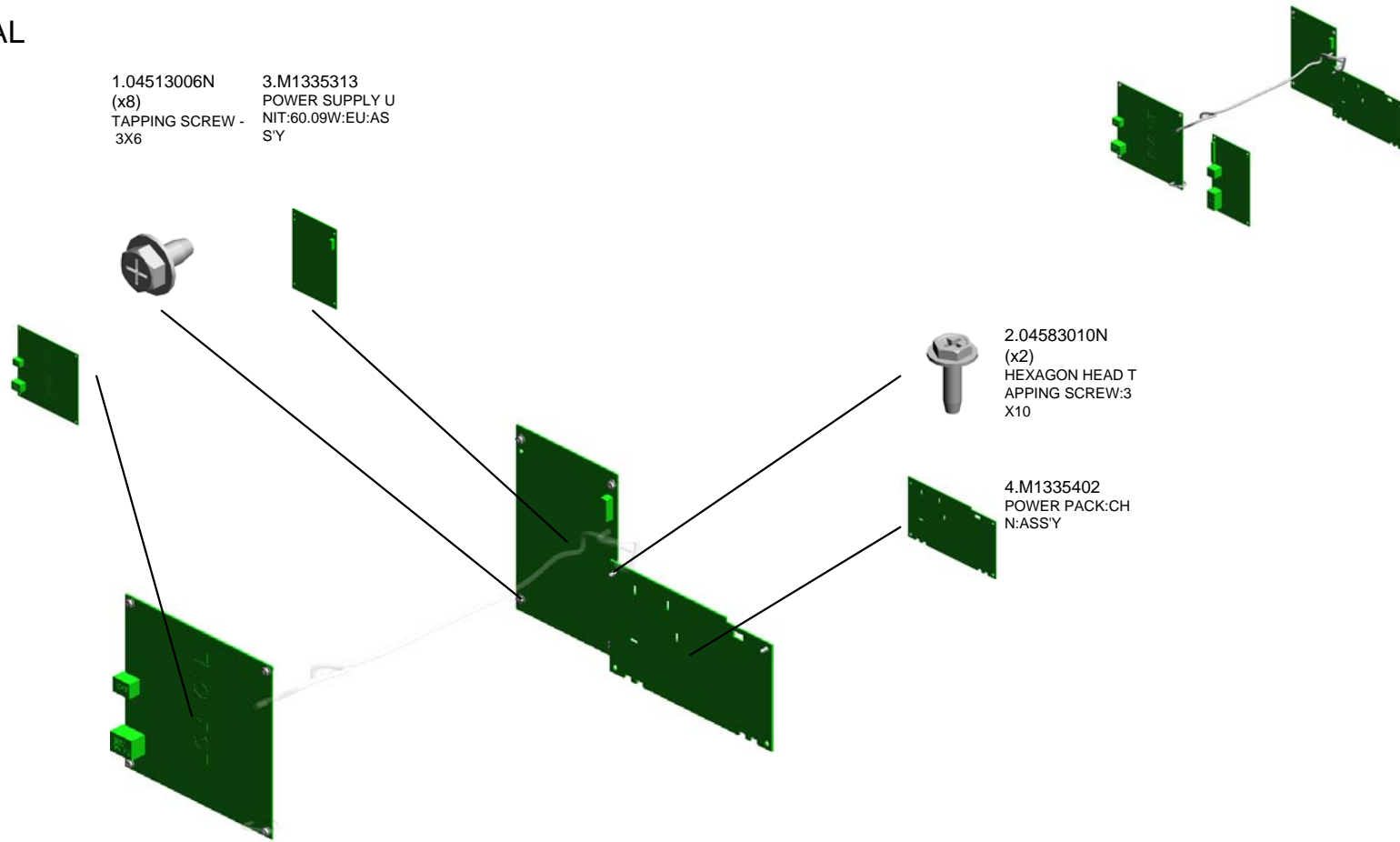

U001	U002	U003	U004	U005	U006	U007	U008	U009	U010	U011	U012
------	------	------	------	------	------	------	------	------	------	------	------



# U012 MAIN FRAME

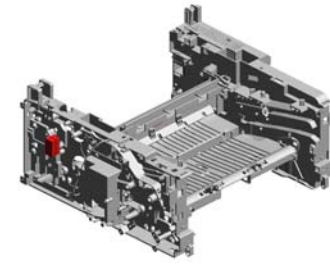

2.04513006N  
(x5)  
TAPPING SCREW -  
3X6

7.M0124699  
DECAL:WARNING (HIGH TEMPERATU  
RE):FRONT

17.M1331094  
COIL SPRING:RIG  
HT:EXIT

19.M1341098  
SHAFT:TURN:SCA  
NNER:RIGHT

11.M1331064  
PAPER TRAY:DISC  
HARGE

18.M1341097  
SHAFT:TURN:SCA  
NNER:LEFT

16.M1331093  
COIL SPRING:LEFT  
:EXIT

15.M1331090  
SAFETY SWITCH:A  
RM

8.M1331061  
COIL SPRING:DISC  
HARGE:ELECTRO  
DE PLATE

10.M1331063  
COIL SPRING:DISC  
HARGE:AIO

5.G5123029  
(x3)  
RUBBER FOOT

1.04503020N  
(x2)  
TAPPING SCREW:  
M3X20

4.12042612  
(x2)  
MICRO SWITCH:D3  
V-16506-3C25

9.M1331062  
ELECTRODE PLAT  
E:TRANSFER

12.M1331066  
(x3)  
COIL SPRING:TER  
MINAL

6.M0121063  
(x3)  
TERMINAL:CHARG  
E

14.M1331068  
COIL SPRING:EAR  
TH:PAPER TRAY

13.M1331067  
COIL SPRING:TRA  
NSFER:CHARGE

3.04583010N  
(x18)  
HEXAGON HEAD T  
APPING SCREW:3  
X10



# ACCESSORIES



1.M1011301  
PLATE:LOGO:RIC



2.M1332715  
COVER:PREVENTFENCE:PAPER TR  
AY:A4

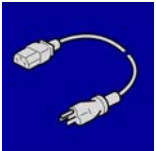

3.M1545699  
POWER SUPPLY CORD:250V:10A:EU

## Exclusive Parts

Number	Part Name	Group	ID
52152713	BOTTOM PLATE PAD	U005_S001_S001	5
AG070514	MAGNET CATCH	U001	2
AW020198	PHOTOINTERRUPTOR:LG2A14NL 1	U005	6
		U008	7
AW110101	THERMOSTAT:LOWER	U008_S001	8
G0113941	CAP:TONER HOPPER:(for M165)	U006	3
G0201160	SNAP RING	U005	7
G5123029	RUBBER FOOT	U001	3
		U012	5
G8003133	SIDE FENCE GEAR	U005	8
		U005_S001	8
M0121063	TERMINAL:CHARGE	U012	6
M0122613	COMPRESSION SPRING:SEPARATION	U005_S001	9
M0122631	CLOTH:EARTH:PAPER FEED	U005	10
M0124454	SPRING:EXIT ROLLER:EXIT	U009	2
M0124488	BUSHING:DIA6XDIA10X6	U005	11
M0124699	DECAL:WARNING (HIGH TEMPERATURE):FRONT	U012	7
M0134622	EXIT ROLLER:DUPLEX	U005	12
M0134623	SPRING:EXIT	U005	13
M1011301	PLATE:LOGO:RIC	ACCESSORIES	1
M1013651	CAP:USED TONER:(for M165)	U006	4
M1014203	HOT ROLLER	U008_S001	9
M1014210	GEAR:HOT ROLLER	U008_S001	10
M1014214	PLAIN SHAFT BEARING:PRESSURE ROLLER	U008_S001	11
M1014222	RETAINING RINGS-C:HOT ROLLER:RIGHT	U008_S001	12
M1014235	RETAINING RINGS-C:HOT ROLLER:LEFT	U008_S001	13
M1014452	GEAR:EXIT ROLLER:PAPER EXIT UNIT	U005	14
M1331061	COIL SPRING:DISCHARGE:ELECTRODE PLATE	U012	8
M1331062	ELECTRODE PLATE:TRANSFER	U012	9
M1331063	COIL SPRING:DISCHARGE:AIO	U012	10
M1331064	PAPER TRAY:DISCHARGE	U012	11

Number	Part Name	Group	ID
M1331066	COIL SPRING:TERMINAL	U012	12
M1331067	COIL SPRING:TRANSFER:CHARGE	U012	13
M1331068	COIL SPRING:EARTH:PAPER TRAY	U012	14
M1331090	SAFETY SWITCH:ARM	U012	15
M1331093	COIL SPRING:LEFT:EXIT	U012	16
M1331094	COIL SPRING:RIGHT:EXIT	U012	17
M1331117	GEAR:DRIVE:DRUM	U010	4
M1331118	GEAR:DRIVE:FUSING:NO.1	U010	5
M1331119	GEAR:DRIVE:FUSING:NO.2	U010	6
M1331120	GEAR:DRIVE:FUSING:NO.3	U010	7
M1331121	GEAR:DRIVE:FUSING:NO.4	U010	8
M1331126	GEAR:DRIVE:EXIT:NO.1	U010	9
M1331127	GEAR:DRIVE:EXIT:NO.2	U010	10
M1331131	GEAR:DRIVE:PAPER FEED:NO.1	U010	11
M1331132	GEAR:DRIVE:PAPER FEED:NO.2	U010	12
M1331133	GEAR:DRIVE:PAPER FEED:NO.3	U010	13
M1331146	SPRING:DRIVE SUB-UNIT:RELEASE	U010	14
M1331155	DC BRUSHLESS MOTOR:20W	U010	15
M1331311	COVER:EXIT:FRAME	U001	4
M1331326	COVER:MANUAL FEED:DOOR	U001	5
M1331327	MANUAL FEED TABLE:ENTRANCE	U001	6
M1331332	COVER:REAR	U001	7
M1331850	OPTICAL WRITING UNIT	U004_S001	2
M1332501	PAPER TRAY:ASS'Y	U005_S001	15
M1332550	BUSHING:FLANGE TYPE:DIA6	U005	16
M1332610	TRAY BOTTOM PLATE	U005_S001_S001	17
M1332620	FRICTION PAD	U005_S001	18
M1332702	COVER:PAPER TRAY	U005_S001	19
M1332703	PAPER TRAY:REAR	U005_S001	20
M1332705	SIDE FENCE:LEFT	U005_S001	21
M1332706	SIDE FENCE:RIGHT	U005_S001	22
M1332707	END FENCE	U005_S001	23
M1332709	STOPPER:BASE	U005_S001	24
M1332710	SPRING:RELEASE:TRAY BOTTOM PLATE	U005_S001	25

## Exclusive Parts

Number	Part Name	Group	ID
M1332712	COMPRESSION SPRING:TRAY BOTTOM PLATE	U005_S001	26
M1332715	COVER:PREVENTFENCE:PAPER TRAY:A4	ACCESSORIES	2
M1332717	DECAL:SIDE FENCE:LEFT	U005_S001	27
M1332718	RUBBER BUSHING:COVER:PAPER TRAY	U005_S001	28
M1332732	FEELER:PAPER END SENSOR:PAPER FEED	U005	29
M1332734	ELECTROMAGNETIC CLUTCH:PAPER FEED	U005	30
M1332735	FILM:PAPER FEED	U005	31
M1332737	SHAFT:FEED	U005	32
M1332741	GUIDE PLATE:CONNECTING	U005	33
M1332742	TRANSPORT ROLLER:CONNECTING	U005	34
M1332743	FEELER:REGISTRATION SENSOR	U005	35
M1332750	GUIDE PLATE:MANUAL FEED:ASSY	U005	36
M1332752	SIDE FENCE:MANUAL FEED:LEFT	U005	37
M1332753	SIDE FENCE:MANUAL FEED:RIGHT	U005	38
M1332754	RACK:SIDE FENCE	U005	39
M1332755	FEELER:MANUAL FEED SENSOR	U005	40
M1332759	PAPER FEED ROLLER	U005	41
M1332762	GROUND PLATE:ROLLER:CONNECTING	U005	42
M1334204	PRESSURE ROLLER:DIA25	U008_S001	14
M1334208	PLAIN SHAFT BEARING:HOT ROLLER	U008_S001	15
M1334216	GUIDE PLATE:STRAIGHT	U008	16
M1334217	FUSING ENTRANCE GUIDE PLATE	U008_S001	17
M1334218	LEVER:PRESSURE	U008_S001	18
M1334219	FEELER:EXIT:SENSOR	U008	19
M1334220	COIL SPRING:FEELER:EXIT	U008	20
M1334221	STRIPPER PAWLS	U008_S001	21
M1334223	TENSION SPRING:PICKOFF PAWL	U008_S001	22
M1334225	FUSING ENTRANCE GUIDE PLATE	U008_S001	23

Number	Part Name	Group	ID
	:UPPER		
M1334226	FLAT NUT:HEATER	U008_S001	24
M1334227	GROUND PLATE:FUSING UNIT	U008_S001	25
M1334228	COVER:FEELER	U008	26
M1334229	LEVER:PRESSURE:LEFT	U008_S001	27
M1334230	LEVER:PRESSURE:RIGHT	U008_S001	28
M1334231	TENSION SPRING:FUSING:PRESSURE	U008_S001	29
M1334240	EXIT ROLLER:STRAIGHT	U008	30
M1334241	HOUSING:THERMOSTAT	U008_S001	31
M1334243	EXIT ROLLER:FUSING	U008_S001	32
M1334244	ELECTRODE:LEFT	U008_S001	33
M1334245	SPRING:EXIT ROLLER:FUSING	U008_S001	34
M1334248	THERMISTOR	U008_S001	35
M1334254	DECAL:WARNING (HIGH TEMPERATURE):REAR PART	U008	36
M1334257	GEAR:DRIVE:STRAIGHT	U008_S001	37
M1334258	GEAR:CONNECTING:STRAIGHT	U008_S001	38
M1334261	HOOK:PRESSURE:LEFT	U008_S001	39
M1334262	HOOK:PRESSURE:RIGHT	U008_S001	40
M1334263	SHEET:HOOK:LEFT	U008_S001	41
M1334264	SHEET:HOOK:RIGHT	U008_S001	42
M1334265	SHEET:PRESSURE RELEASE:LEFT	U008_S001	43
M1334266	SHEET:PRESSURE RELEASE:RIGHT	U008_S001	44
M1334451	EXIT ROLLER:PAPER EXIT UNIT	U009	3
M1334453	PLAIN SHAFT BEARING:EXIT	U009	4
M1334457	EXIT ROLLER	U009	5
M1334459	EXIT ROLLER	U009	6
M1334465	PLATE:EXIT	U009	7
M1334466	GUIDE PLATE:EXIT:UPPER	U009	8
M1334467	GUIDE PLATE:EXIT:LOWER	U009	9
M1334485	EXTENSION TRAY:EXIT:P	U001	8
M1334486	TRAY:EXIT:P	U001	9
M1335313	POWER SUPPLY UNIT:60.09W:EU:ASSY	U011	3
M1335402	POWER PACK:CHN:ASSY	U011	4

## Exclusive Parts

Number	Part Name	Group	ID
M1336201	SEPARATION UNIT:ASS'Y	U007	1
M1336250	TRANSFER ROLLER	U007	2
M1336254	GEAR:TRANSFER ROLLER	U007	3
M1336259	ROLLER:POSITIONING:TRANSFER ROLLER	U007	4
M1336262	BUSHING:TRANSFER ROLLER:RIG HT	U007	5
M1336263	BUSHING:TRANSFER ROLLER:LE FT	U007	6
M1336264	SPRING:TRANSFER ROLLER	U007	7
M1341097	SHAFT:TURN:SCANNER:LEFT	U012	18
M1341098	SHAFT:TURN:SCANNER:RIGHT	U012	19
M1341253	COVER:SIDE PLATE:LEFT:MF	U001	10
M1341257	COVER:FAX:3IN1	U001	11
M1341261	COVER:SIDE PLATE:RIGHT:MF	U001	12
M1341314	COVER:UPPER:MF	U001	13
M1341321	COVER:FRONT:M134/M165:(for M1 65)	U001	14
M1341344	COVER:REAR LOWER:MF	U001	15
M1341372	COIL SPRING:SCANNER:OPEN AN D CLOSE	U001	16
M1341382	RAIL:SCANNER:OPEN AND CLOSE	U001	17
M1341386	RAIL:STOPPER:SCANNER:OPEN A ND CLOSE	U001	18
M1341392	GUIDE PLATE:SCANNER:OPEN AN D CLOSE	U001	19
M1341600	SCANNER:ASS'Y	U003	1
M1454212	HEATER:700W:230V	U008_S001	45
M1470051	OPERATION PANEL:ASS'Y:EU/AP: M147/M165	U002	1
M1471321	COVER:FRONT:M147-17/27:(for M1 47)	U001	20
M1475050	PCB:ECBCTL:WW:ASS'Y:M147/M1 65	U011	5
M1494002	FUSING UNIT:EU/AP:ASS'Y	U008_S001	46
M1545699	POWER SUPPLY CORD:250V:10A: EU	ACCESSORIES	3

## Standard Parts



03530030N  
SCREW:M3X3



04503012N  
TAPPING SCREW:3X12



04503014N  
TAPPING SCREW:M3X14



04503020N  
TAPPING SCREW:M3X20



04513006N  
TAPPING SCREW - 3X6



04513008N  
TAPPING SCREW - M3X8



04523014N  
BINDING SELF-TAPPING SCREW:M3X14



04583010N  
HEXAGON HEAD TAPPING SCREW:3X10



04583012N  
HEXAGON HEAD TAPPING SCREW:3X12



07200040E  
RETAINING RING - M4



07200060E  
RETAINING RING - M6



08046127  
HEXAGONAL BOLT:DOUBLE SCREW:M3X8



08050089  
RETAINING RING - M4



12042612  
MICRO SWITCH:D3V-16506-3 C25

