

SP 330SN/330SFN/3710SF
(M0C4/M0C5/M0C7-EU/AA)
Parts Catalog

Parts change information sample

 **Add**

 **Update**

 **Delete**

Model	Product Code	PC Style
SP 330SN	M0C4	3D
SP 330SFN	M0C5	
SP 3710SF	M0C7	
SP 330DN	M0C3	3D
SP 3710DN	M0C6	
Paper Feed Unit PB1130	M534	3D
ARDF	M2891601	Traditional

Unit All

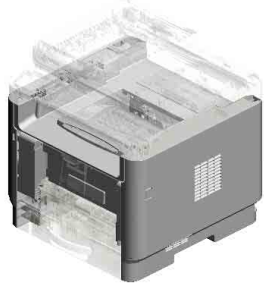

U001
EXTERIOR

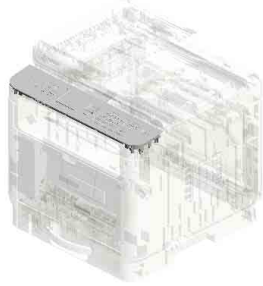

U002
OPERATION

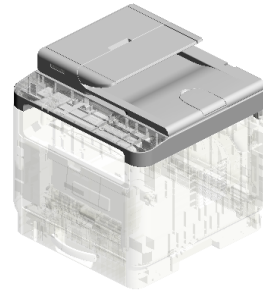

U003
ADF/ARDF/SCANNER

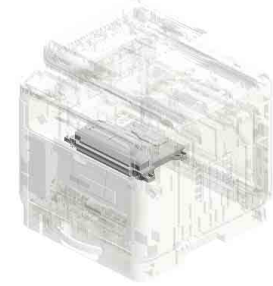

U004
LASER UNIT

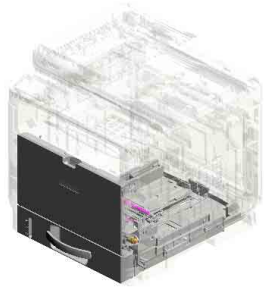

U005
PAPER FEED



U006
PCU

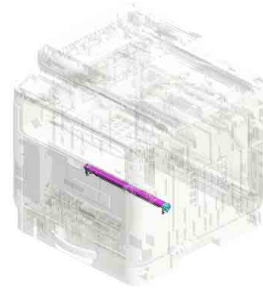

U007
TRANSFER/SEPARATION

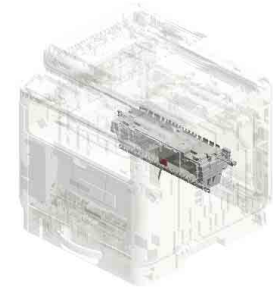

U008
FUSING

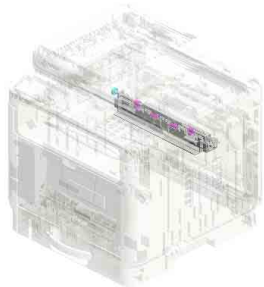

U009
PAPER EXIT

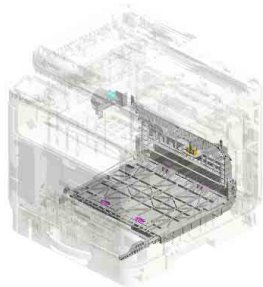

U010
DUPLEX

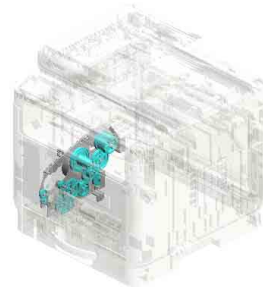

U011
MAIN DRIVE

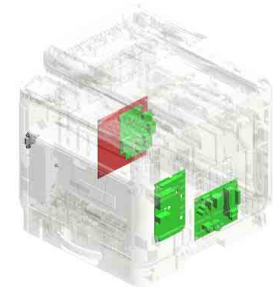

U012
ELECTRICAL

Unit All

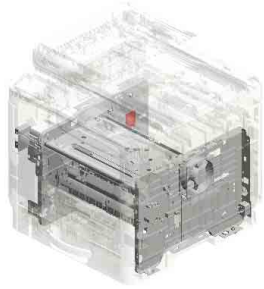

U013
MAIN FRAME

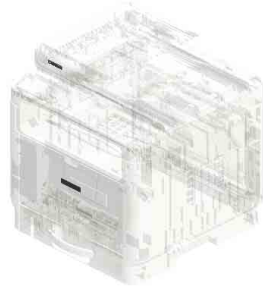

U014
ACCESSORIES

U001 EXTERIOR

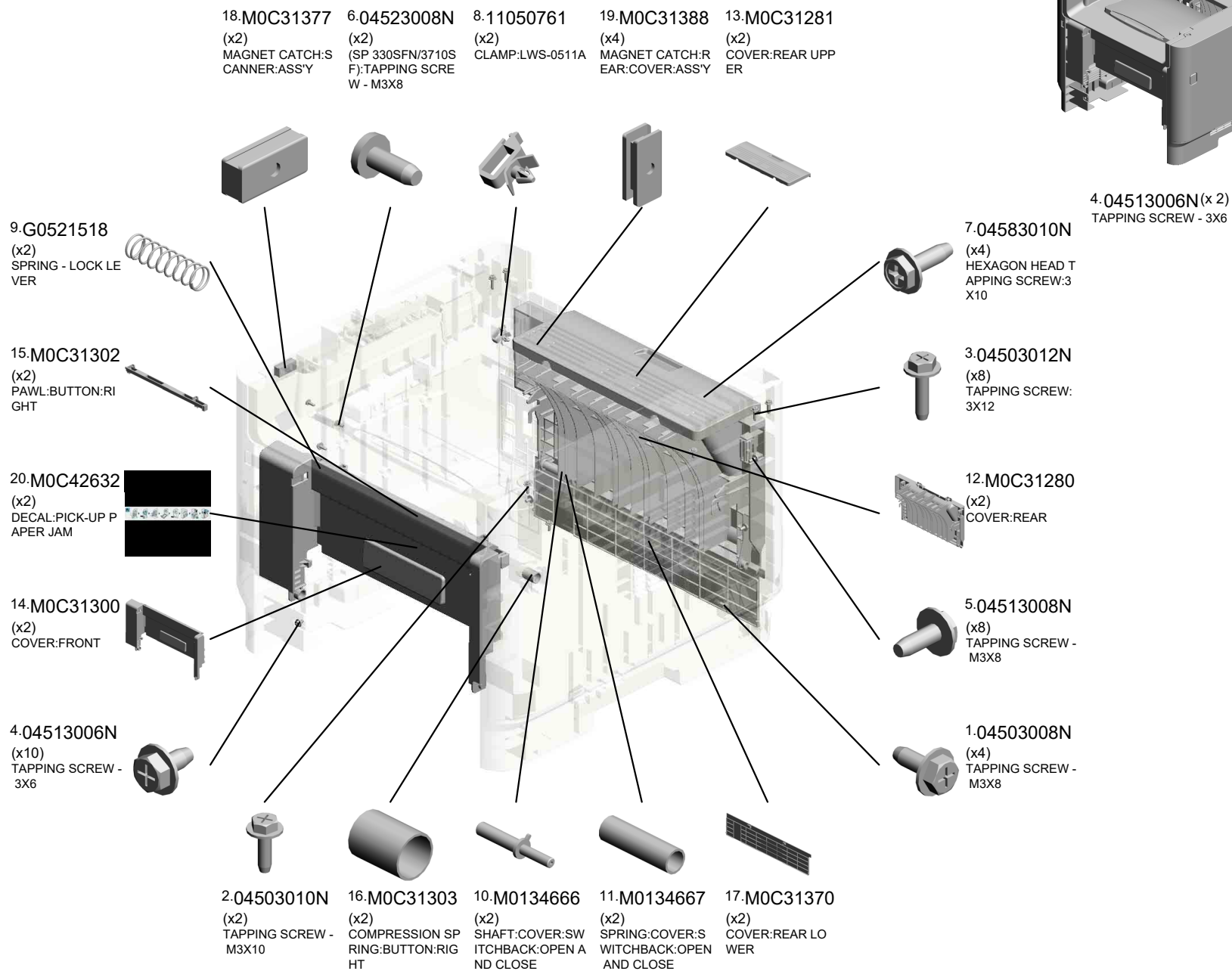
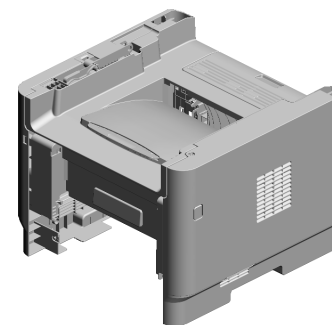

U001 EXTERIOR

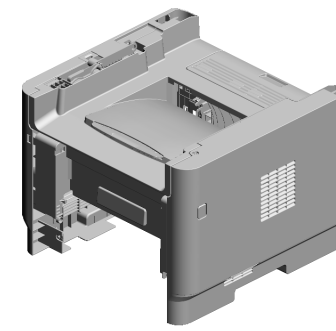

- 30.M1341382 (x2) RAIL:SCANNER:OPEN AND CLOSE
- 31.M1341386 (x2) RAIL:STOPPER:SCANNER:OPEN AND CLOSE
- 32.M1561272 (x2) COIL SPRING:SCANNER
- 33.M1561392 (x2) GUIDE PLATE:SCANNER:OPEN AND CLOSE

29.M1180501 (SP 330SFN/3710SF):SPEAKER:M118

27.M0C51266 (x2) (CHN[SP 330SN]/NA/EU/AA):COVER:SIDE PLATE:LEFT

26.M0C51264 (x2) EXTENSION TRAY:GUIDE

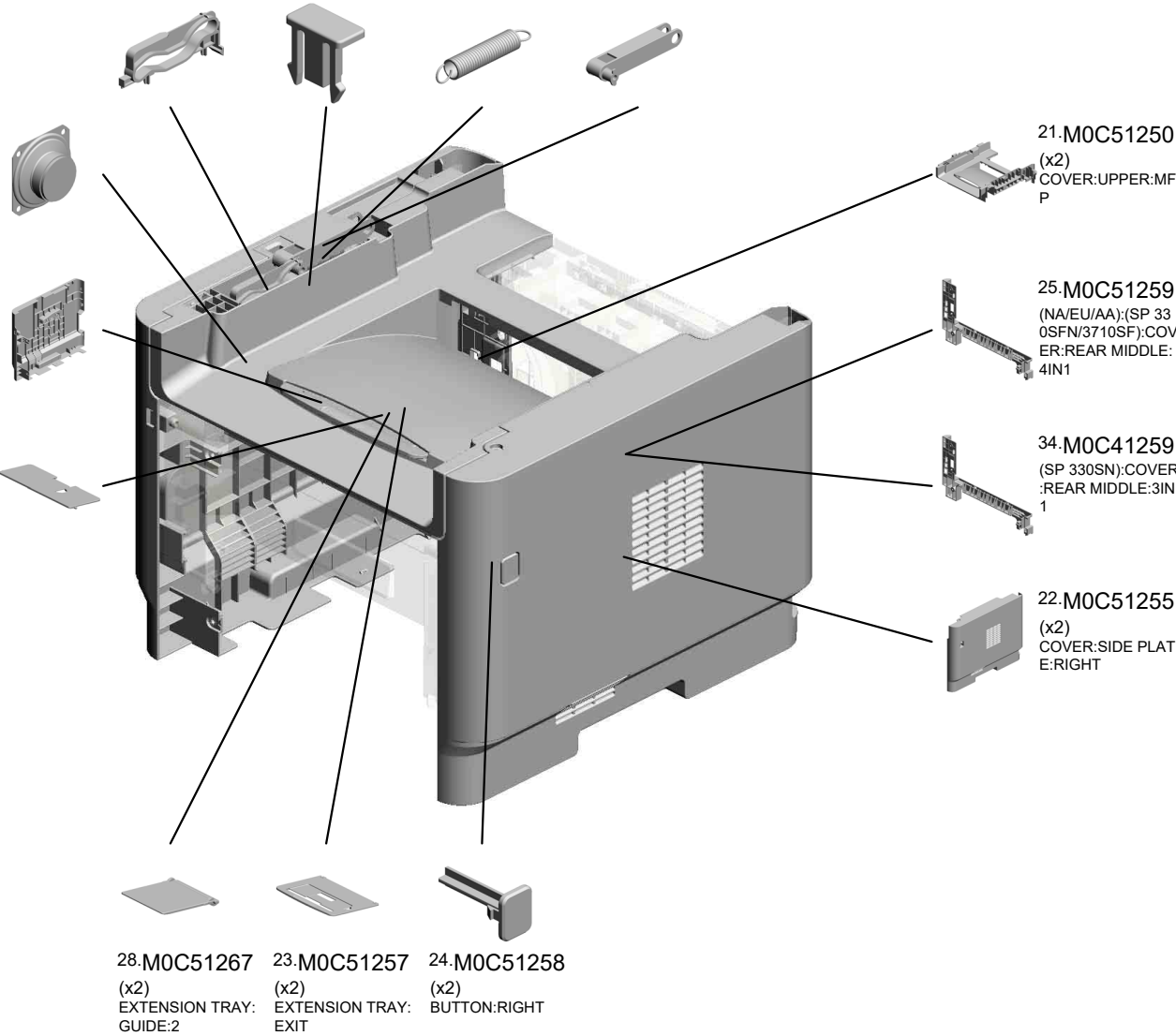

21.M0C51250 (x2) COVER:UPPER:MFP

25.M0C51259 (NA/EU/AA):(SP 330SFN/3710SF):COVER:REAR MIDDLE:4IN1

34.M0C41259 (SP 330SN):COVER:REAR MIDDLE:3IN1

22.M0C51255 (x2) COVER:SIDE PLATE:RIGHT

- 28.M0C51267 (x2) EXTENSION TRAY:GUIDE:2
- 23.M0C51257 (x2) EXTENSION TRAY:EXIT
- 24.M0C51258 (x2) BUTTON:RIGHT

U002 OPERATION

4.M0C51402
(NA/EU/AA):(SP 33
0SFN/3710SF):OPE
RATION SUB-UNIT:
4.3INCH:ASS'Y

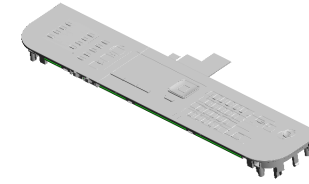
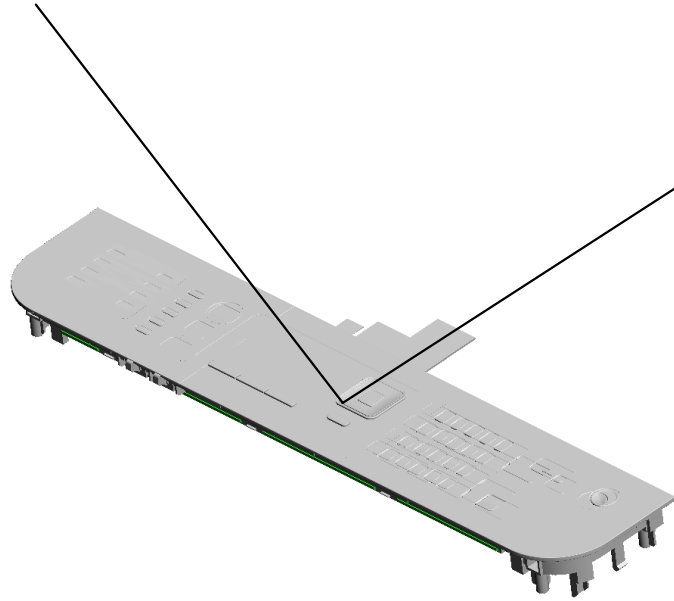

1.04593010N(x14)
BINDING HEAD TAPPING SCREW:3X10

5.M0C41402
(EU/AA):(SP 330SN
) :OPERATION SUB-
UNIT:4L:3IN1:ASS'
Y



U001	U002	U003	U004	U005	U006	U007	U008	U009	U010	U011	U012	U013	U014
------	-------------	------	------	------	------	------	------	------	------	------	------	------	------

U003.ADF/ARDF/SCANNER

U003 S001
M0C51601
(SP 330SFN/3710SF):ARDF:A
SS'Y

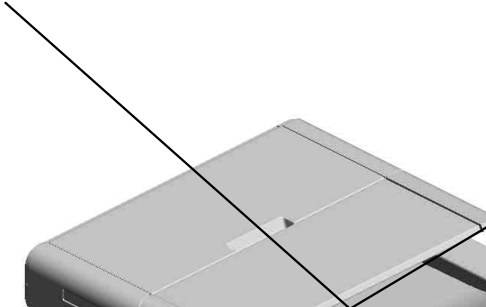
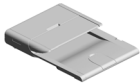

U003 S002
M1561640
(SP 330SN):ADF:ASS'Y

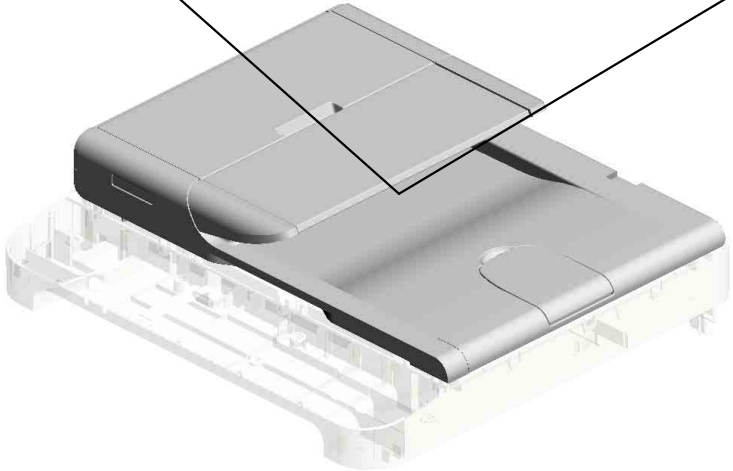
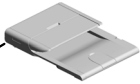

U001	U002	U003	U004	U005	U006	U007	U008	U009	U010	U011	U012	U013	U014
------	------	------	------	------	------	------	------	------	------	------	------	------	------

U003
ADF/ARDF/SCANNER

2.M0C41600
(SP 330SN):SCANN
ER:ASS'Y

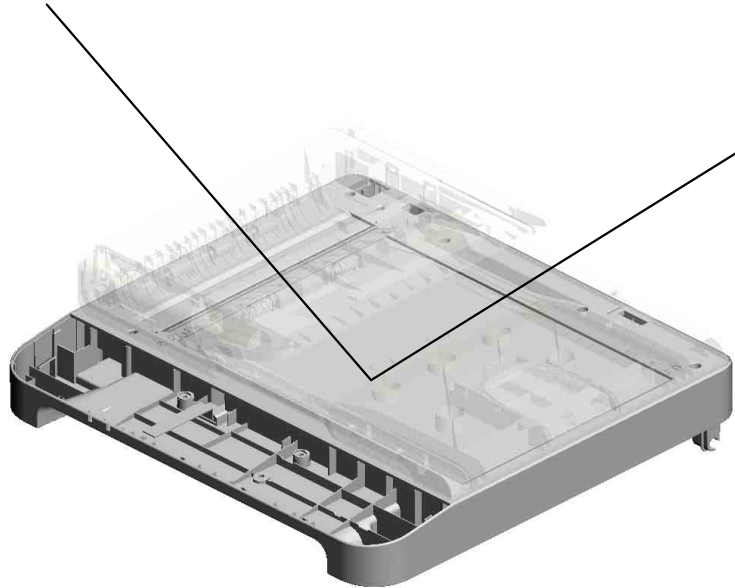
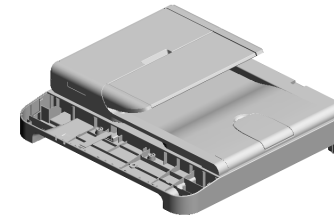

3.M0C51600
(SP 330SFN/3710S
F):SCANNER:ASS'
Y

1.04513006N(x 2)
TAPPING SCREW - 3X6

U001	U002	U003	U004	U005	U006	U007	U008	U009	U010	U011	U012	U013	U014
------	------	------	------	------	------	------	------	------	------	------	------	------	------

U003_S001
(SP 330SFN/3710SF):ARDF:ASS'Y

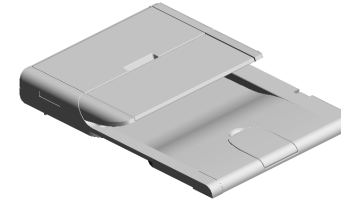

6.M0C51601
[A]
(SP 330SFN/3710S
F):ARDF:ASS'Y
201810-01 O/O

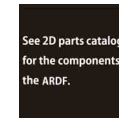

7.Note
See 2D parts catalog for the components of the ARDF.



M2891601
[A]
(SP 330SFN/3710S
F):ARDF:ASS'Y
201810-01 O/O

U001	U002	U003	U004	U005	U006	U007	U008	U009	U010	U011	U012	U013	U014
------	------	------	------	------	------	------	------	------	------	------	------	------	------

U003_S002
(SP 330SN):ADF:ASS'Y

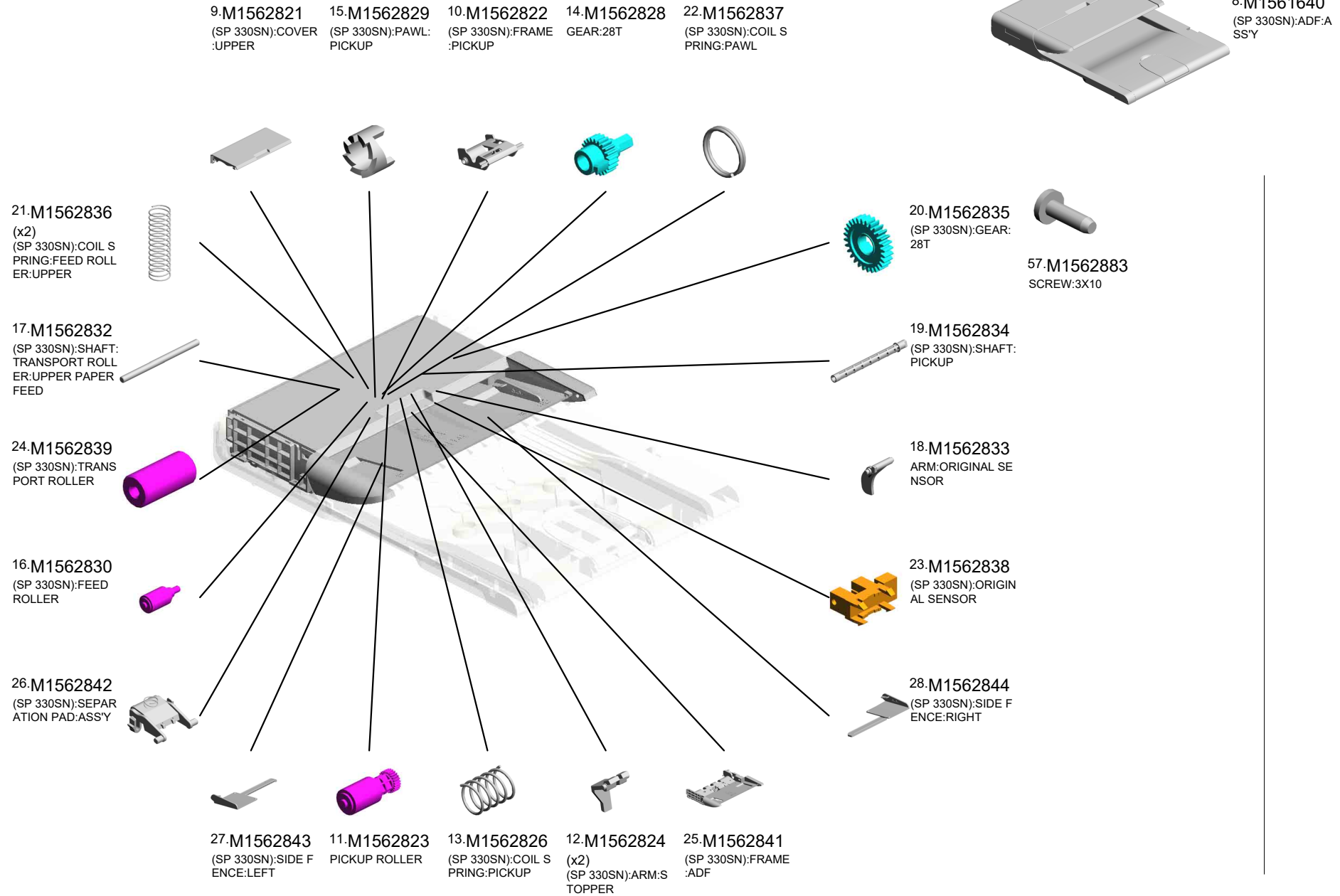

U003_S002
(SP 330SN):ADF:ASS'Y

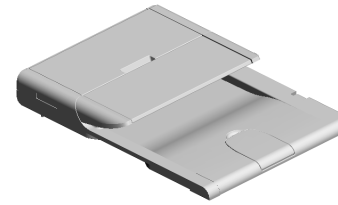

8.M1561640
(SP 330SN):ADF:ASS'Y

- 39.M1562855 (SP 330SN):REGISTRATION SENSOR
- 35.M1562851 (SP 330SN):GEAR:46T
- 44.M1562860 (SP 330SN):PLAIN SHAFT BEARING:RIGHT
- 37.M1562853 (SP 330SN):GEAR:53T
- 34.M1562850 (SP 330SN):GEAR:39T

45.M1562861
(SP 330SN):REGISTRATION ROLLER:ASS'Y

46.M1562862
(SP 330SN):ARM:REGISTRATION SENSOR

47.M1562863
(SP 330SN):FRAME:LOWER

42.M1562858
(SP 330SN):PLAIN SHAFT BEARING:RIGHT:EXIT ROLLER

41.M1562857
PLAIN SHAFT BEARING:LEFT:EXIT ROLLER

48.M1562864
(SP 330SN):DISCHARGE BRUSH

40.M1562856
(SP 330SN):EXIT ROLLER

38.M1562854
(SP 330SN):GEAR:18T

36.M1562852
(SP 330SN):GEAR:43T

43.M1562859
(SP 330SN):PLAIN SHAFT BEARING:LEFT:REGISTRATION ROLLER

30.M1562846
(x2)
SCREW:3X4

33.M1562849
(SP 330SN):GEAR:37T

32.M1562848
(SP 330SN):GEAR:28T

29.M1562845
(SP 330SN):GROUND PLATE

31.M1562847
(SP 330SN):GEAR:21T

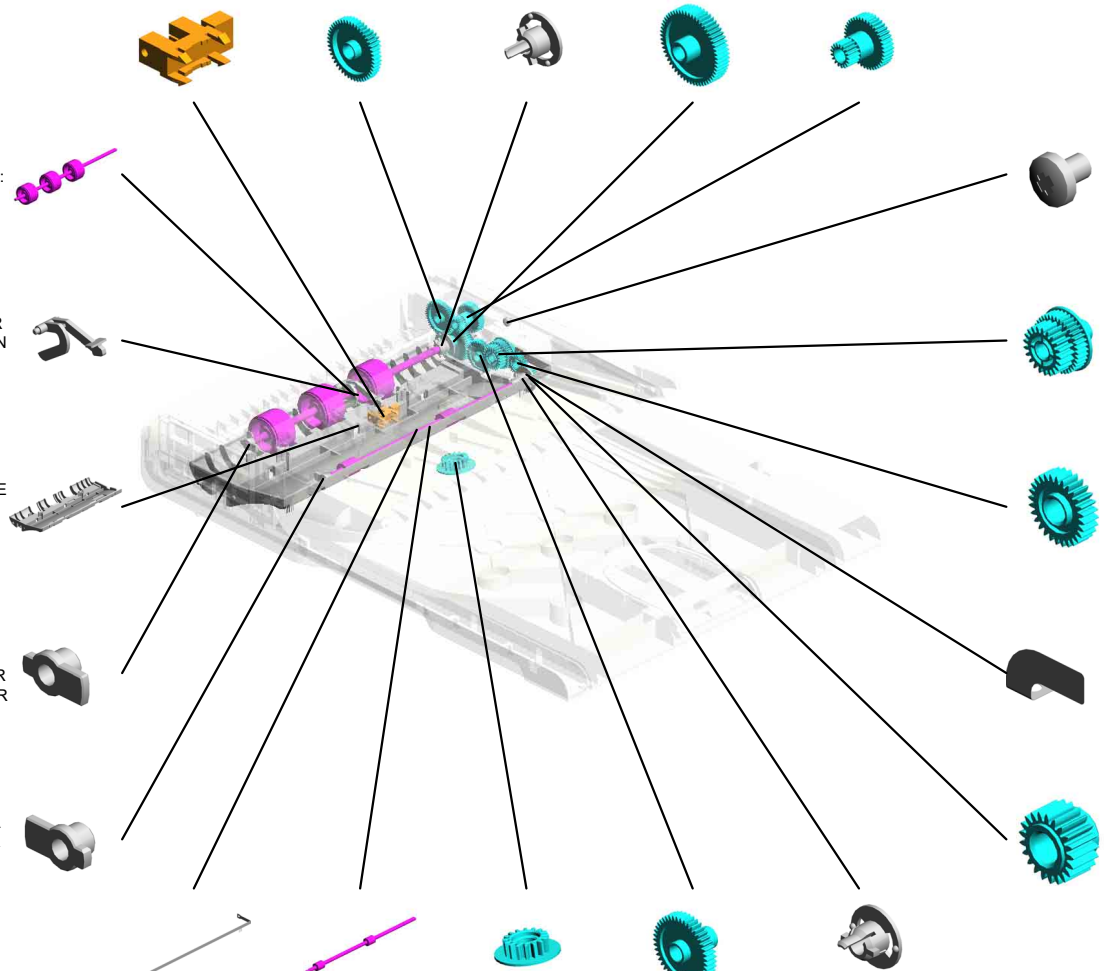

U003_S002
(SP 330SN):ADF:ASS'Y

- 52.M1562869 (SP 330SN):PLATE:ADF
- 57.M1562883 (x2) SCREW:3X10
- 58.M1562884 (SP 330SN):HINGE:LEFT:ASS'Y
- 49.M1562865 (SP 330SN):FRAME:MOTOR:ADF
- 50.M1562866 (SP 330SN):MOTOR:ADF

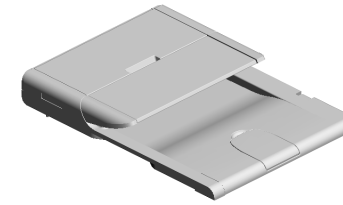

- 8.M1561640 (SP 330SN):ADF:ASS'Y

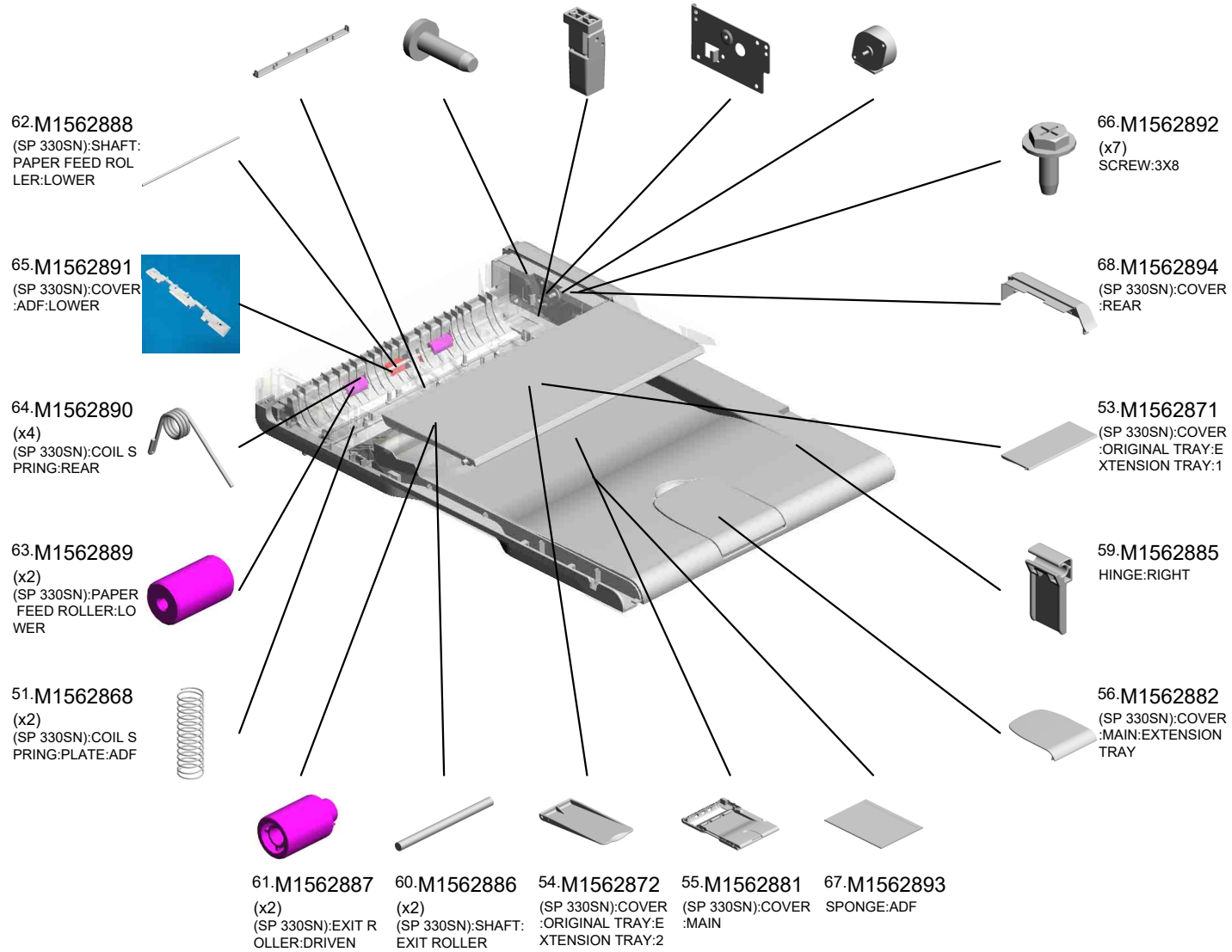

U003_S002
(SP 330SN):ADF:ASS'Y

73.M2021779
(SP 330SN):DISCHARGE BRUSH:MECHANICAL SPRING CLUTCH

74.M2021780
(SP 330SN):GEAR:22T

75.M2021781
(SP 330SN):PAWL:MECHANICAL SPRING CLUTCH:M202

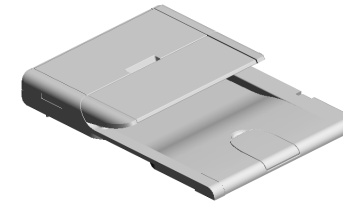

8.M1561640
(SP 330SN):ADF:ASS'Y

72.M1562899
(x2)
(SP 330SN):SHEET OUTLET

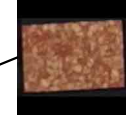

70.M1562896
(SP 330SN):PAD:PICKUP

71.M1562898
SCREW:3X6

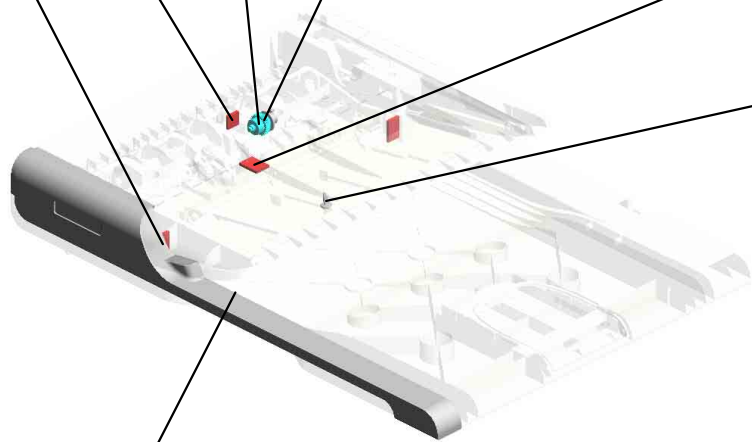

69.M1562895
(SP 330SN):COVER:FRONT



U004.LASER UNIT

U004 S001
MOC31850
OPTICAL WRITING UNIT:ASS
Y

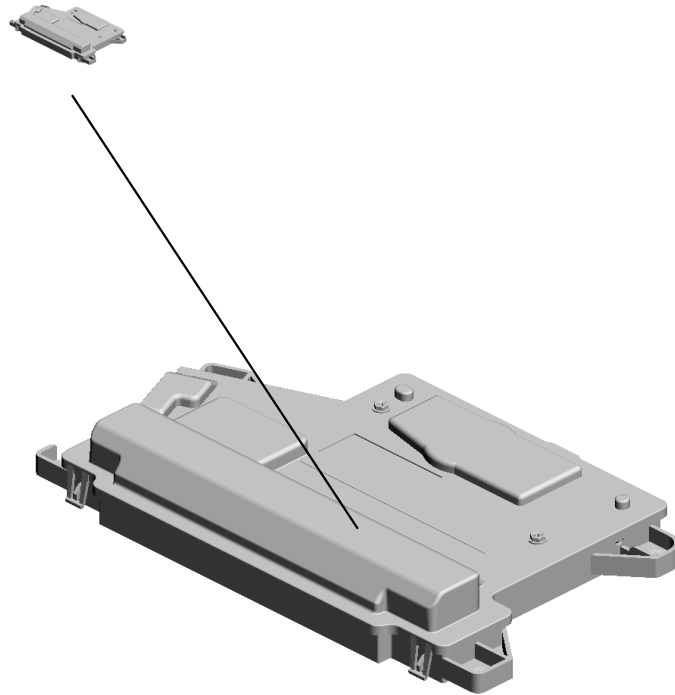

U001	U002	U003	U004	U005	U006	U007	U008	U009	U010	U011	U012	U013	U014
------	------	------	------	------	------	------	------	------	------	------	------	------	------

U004
LASER UNIT

2.04543008Q
(x4)
TAPPING SCREW:
3X8

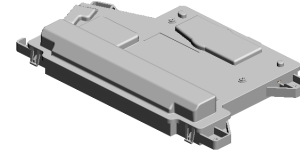

U001	U002	U003	U004	U005	U006	U007	U008	U009	U010	U011	U012	U013	U014
------	------	------	-------------	------	------	------	------	------	------	------	------	------	------

U004_S001
OPTICAL WRITING UNIT:ASS'Y

3.04583010N
(x2)
HEXAGON HEAD TAPPING SCREW:3X10

4.04593010N
(x2)
BINDING HEAD TAPPING SCREW:3X10

5.G1271088
THERMISTOR

1.04523010N
BINDING SELF-TAPPING SCREW:3X10

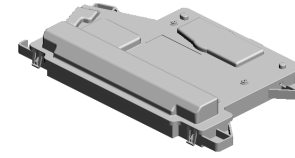

6.M0C31850
OPTICAL WRITING UNIT:ASS'Y

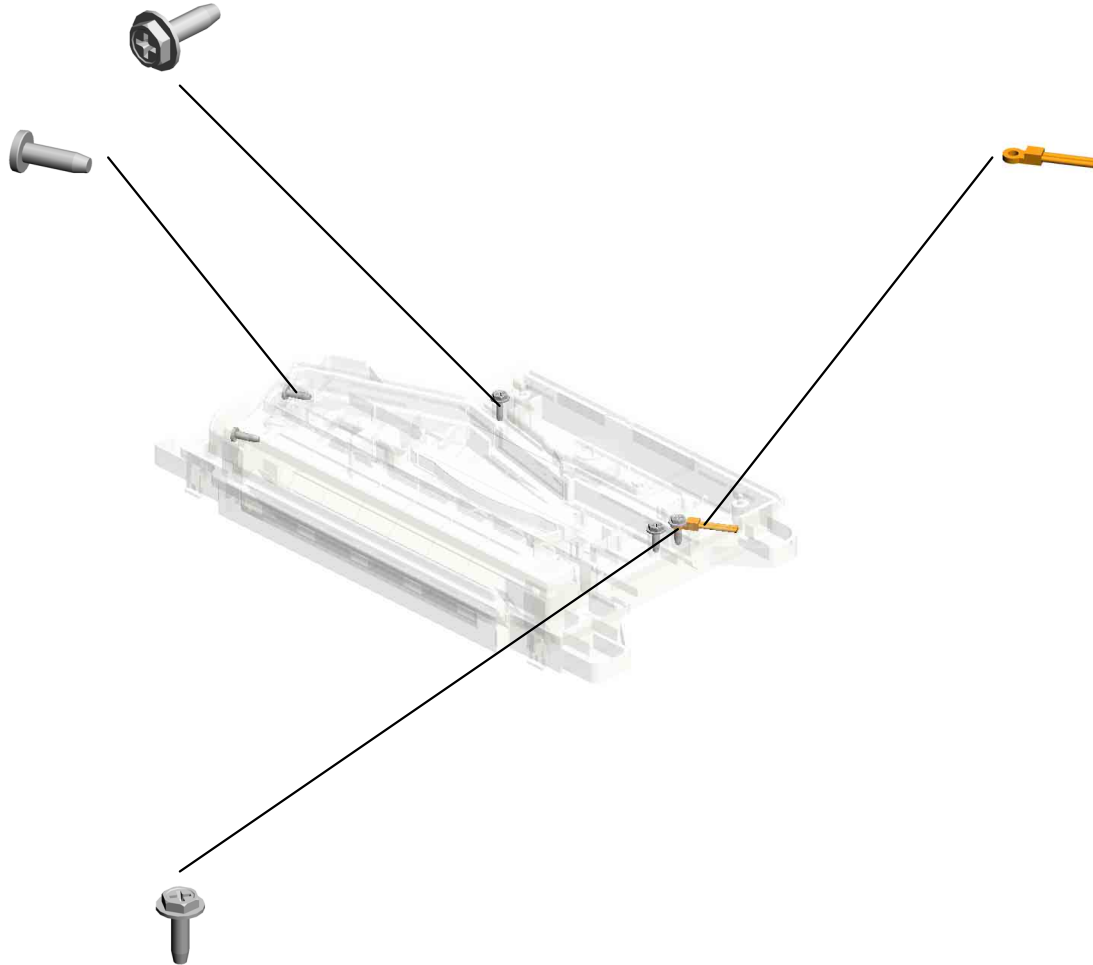

U001	U002	U003	U004	U005	U006	U007	U008	U009	U010	U011	U012	U013	U014
------	------	------	------	------	------	------	------	------	------	------	------	------	------

U005.PAPER FEED

U005_S002
M0122740
GUIDE PLATE:TRANSPORT:
ASSY

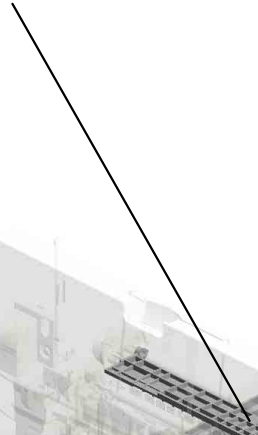

U005_S001
M0C32505
PAPER TRAY:ASS'Y

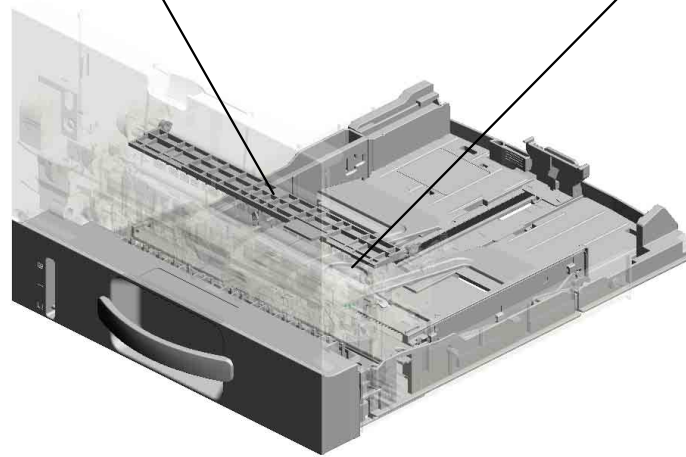
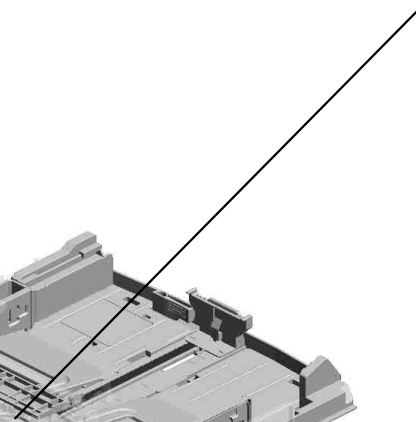

U001	U002	U003	U004	U005	U006	U007	U008	U009	U010	U011	U012	U013	U014
------	------	------	------	------	------	------	------	------	------	------	------	------	------

U005 PAPER FEED

- 4.04523010N (x2) BINDING SELF-TAPPING SCREW:3X10
- 17.G1022717 COVER:DC SOLENOID
- 7.08050104 (x6) RETAINING RINGS -E:SILENCER:DIA4
- 29.M0122631 CLOTH:EARTH:PA PER FEED
- 8.A1532117 ROLLER TERMINAL

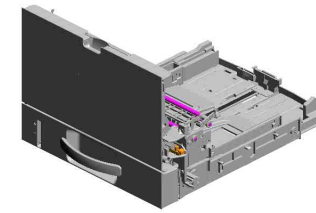

19.G1271088
THERMISTOR



12.D3ER1068 (x2) ROLLER:DETENT: PAPER TRAY



13.D3ER1069 (x2) ROLLER:DETENT: PAPER TRAY:NO.2



6.08050103 (x2) RETAINING RINGS -E:SILENCER:DIA3



10.D1272514 (x3) ELECTROMAGNETIC CLUTCH:3.5T:MANUAL FEED



23.GW020022 (x3) PHOTOINTERRUPTOR:LG2A24BL1



22.GF013001 BOTTOM PLATE PAD



16.G0292767 BY-PASS FEED COVER



20.G1272627 PAPER FEED ROLLER - MM32



3.04513006N (x8) TAPPING SCREW - 3X6



14.G0123050 SIDE FENCE GEAR



7.08050104 RETAINING RINGS -E:SILENCER:DIA4



11.D1441085 STEPPED SCREW: M3



15.G0201160 (x2) SNAP RING



1.04503008N (x2) TAPPING SCREW - M3X8



18.G1022789 STOPPER:PHOTO INTERRUPTOR



U005 PAPER FEED

- 34.M0122711 BUSHING:REGISTRATION:DRIVEN:LEFT
- 39.M0122723 FEELER:REGISTRATION:SENSOR
- 46.M0122744 (x2) GUIDE:REGISTRATION
- 31.M0122701 ROLLER:INTERFACEDRIVE
- 36.M0122718 REGISTRATION ROLLER:DRIVEN

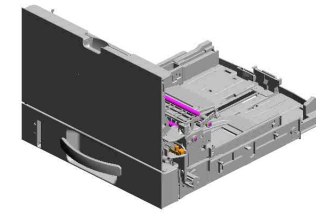

- 44.M0122742 GROUND PLATE:DRIVEN:REGISTRATION ROLLER

- 43.M0122741 GROUND PLATE:DRIVE:REGISTRATION ROLLER

- 52.M0122830 MECHANICAL SPRING CLUTCH:MANUAL FEED

- 40.M0122725 SPRING:FEELER:REGISTRATION

- 30.M0122668 SHAFT:PAPER FEED:ASSY

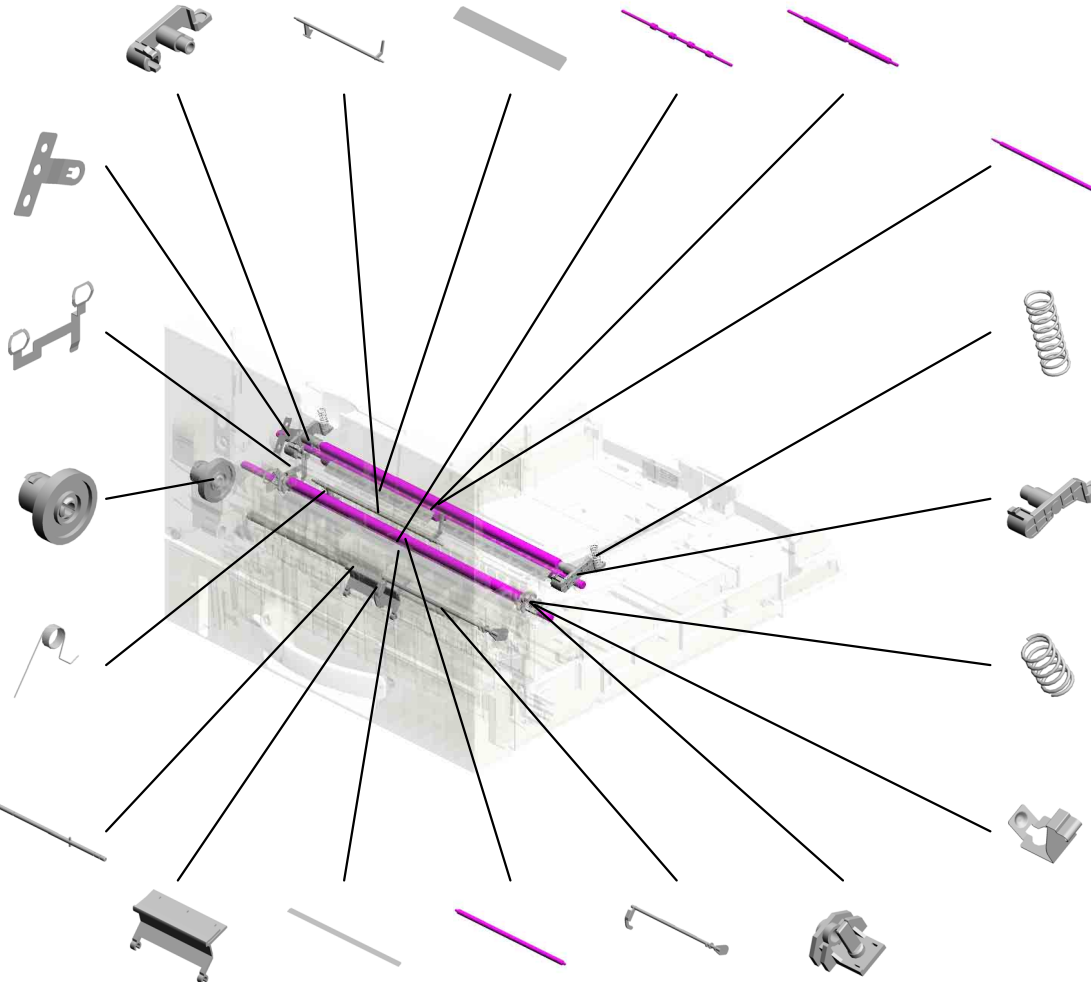

- 37.M0122719 REGISTRATION ROLLER:DRIVEN

- 38.M0122722 (x2) SPRING:ROLLER:REGISTRATION

- 41.M0122730 BUSHING:REGISTRATION:DRIVEN:RIGHT

- 33.M0122705 (x2) SPRING:ROLLER

- 47.M0122745 GROUND PLATE:DRIVEN

- 50.M0122816 FRICTION PAD:HOLDER:MANUAL FEED:ASSY
- 49.M0122806 SHEET:GUIDE:MANUAL FEED SUBUNIT
- 32.M0122702 ROLLER:INTERFACEDRIVEN
- 51.M0122824 FEELER:MANUAL FEED
- 48.M0122753 (x2) BUSHING:ROLLER:DRIVEN

U005 PAPER FEED

- 77.M1542879 EXTENSION TRAY: MANUAL FEED
- 63.M0C32672 RAIL:PAPER TRAY: LEFT
- 92.M2872875 SIDE FENCE:MANUAL FEED:RIGHT
- 94.M2872878 (x2) RACK:MANUAL FEED
- 53.M0122833 DECAL:SIDE FENCE:MANUAL FEED

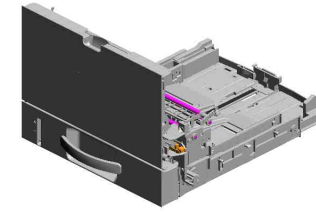

- 76.M1542831 DC SOLENOID:9.6W:24V

- 93.M2872876 SIDE FENCE:MANUAL FEED:LEFT

- 69.M0C32881 COVER:MANUAL FEED TABLE

- 65.M0C32678 (x2) COMPRESSION SPRING:DETENT:PAPER TRAY

- 66.M0C32681 (x2) DETENT:PAPER TRAY

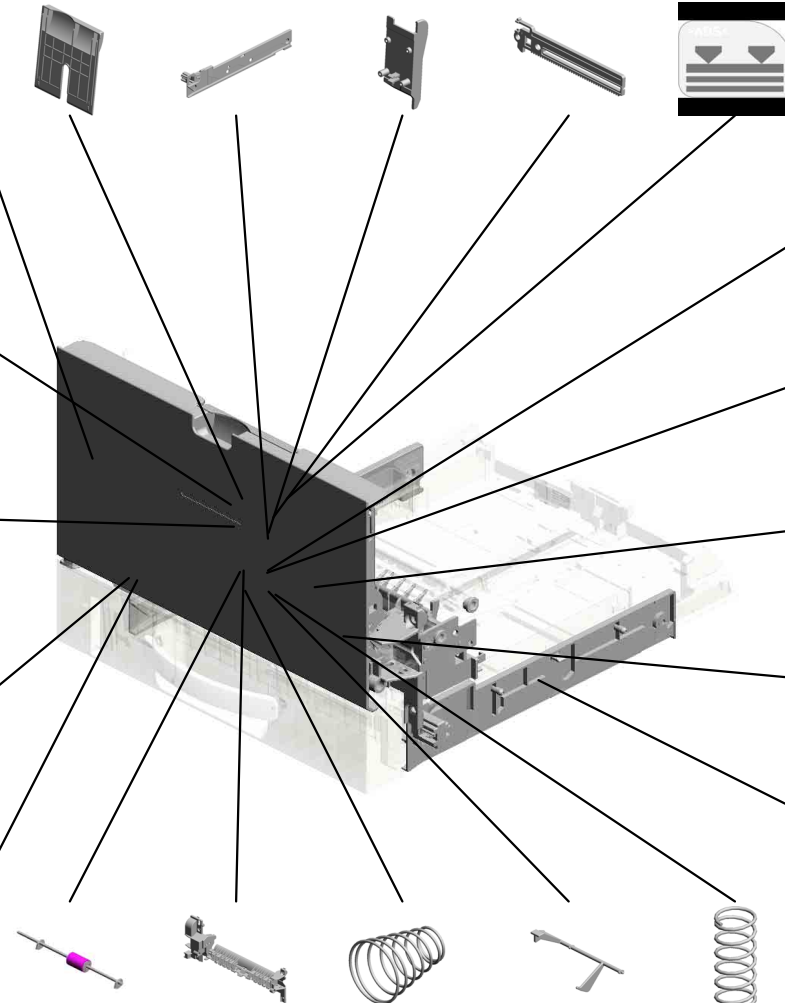

- 95.M2872879 (x2) COMPRESSION SPRING:SIDE FENCE:MANUAL FEED

- 67.M0C32804 GUIDE PLATE:UPPER:MANUAL FEED

- 75.M1542707 STAY:PAPER FEED

- 57.M0124488 (x6) BUSHING:DIA6XDI A10X6

- 64.M0C32673 RAIL:PAPER TRAY: RIGHT

- 54.M0122860 PAPER FEED ROLLER:MANUAL FEED
- 68.M0C32805 GUIDE PLATE:MANUAL FEED:LOWER
- 55.M0122874 COMPRESSION SPRING:MANUAL FEED
- 91.M0C32691 FEELER:PAPER END SENSOR 202001-01 O/O
- 56.M0122880 COMPRESSION SPRING:SEPARATION

U005
PAPER FEED

97.M1542815
DECAL:FEED PAPER AGAIN:PREVENTION

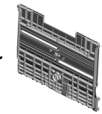
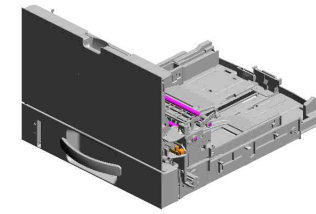

96.M2872881
BASE:MANUAL FEED TABLE

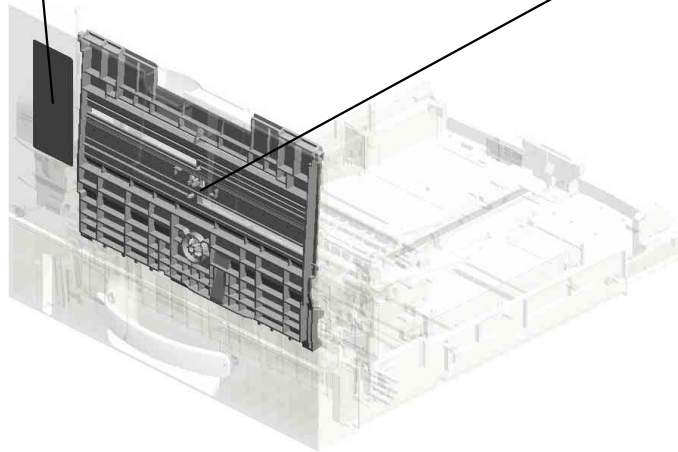

U001	U002	U003	U004	U005	U006	U007	U008	U009	U010	U011	U012	U013	U014
------	------	------	------	-------------	------	------	------	------	------	------	------	------	------

U005_S001
PAPER TRAY:ASS'Y

58.M0752610
(x4)
COMPRESSION SP
RING:LOCK:SIDE F
ENCE

71.M1092589
LEVER:LOCK:SIDE
FENCE

72.M1092592
PAWL:LOCK:SIDE
FENCE

28.M0122613
COMPRESSION SP
RING:SEPARATIO
N

24.M0122590
COIL SPRING:EAR
TH

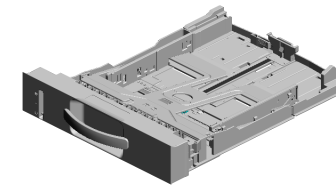

59.M0C32505
PAPER TRAY:ASS'
Y

61.M0C32616
LEVER:PAPER VO
LUME SENSOR

74.M1542618
DECAL:PAPER TR
AY:FRONT

26.M0122605
FRICTION PAD:AD
HESION

62.M0C32629
COVER:PAPER TR
AY

9.D0A42695
GRIP:PAPER TRAY

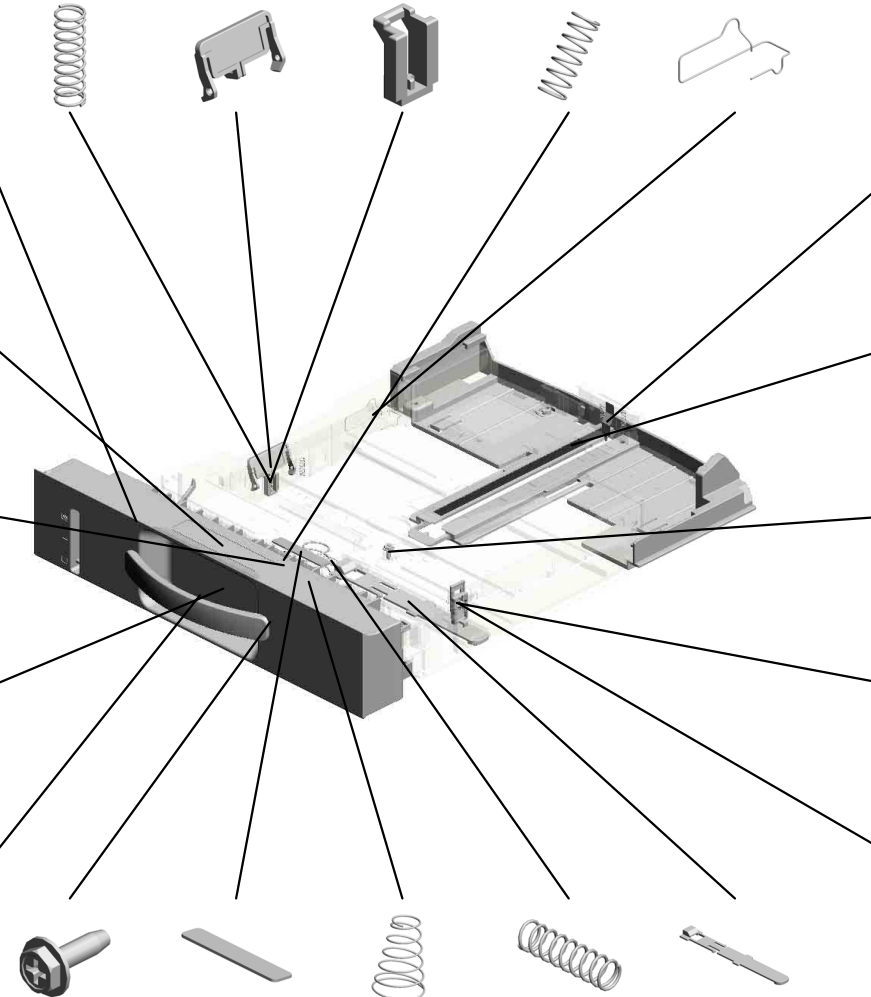

60.M0C32614
SPONGE:END FEN
CE

78.M2872589
PAPER TRAY:REA
R

2.04504008N
TAPPING SCREW -
M4X8

21.GA063084
COMPRESSION SP
RING:AUXILIARY:S
IDE FENCE

70.M1092584
PRESSURE PLATE
:SIDE FENCE:LEFT

5.04583010N
(x2)
HEXAGON HEAD T
APPING SCREW:3
X10

22.GF013001
BOTTOM PLATE P
AD

27.M0122612
COMPRESSION SP
RING:TRAY BOTTO
M PLATE

73.M1332710
SPRING:RELEASE:
TRAY BOTTOM PL
ATE

25.M0122603
STOPPER:BASE P
LATE

U005_S001
PAPER TRAY:ASS'Y

82.M2872618 COVER:SIDE FENCE:LEFT
79.M2872611 TRAY:BASE
88.M2872626 DECAL:EXTENSION TRAY

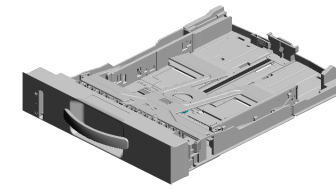

59.M0C32505
PAPER TRAY:ASS'Y



86.M2872624
(x2)
CLICK:SIDE FENCE



81.M2872615
SIDE FENCE:LEFT



90.M2872636
GEAR:16Z



89.M2872627
LEVER:LOCK:END FENCE



80.M2872612
END FENCE

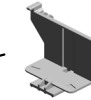

85.M2872623
PAWL:LOCK:END FENCE



83.M2872620 SIDE FENCE:RIGHT
87.M2872625 LEVER:LOCK:EXTENSION TRAY
84.M2872622 COVER:SIDE FENCE:RIGHT



U005_S002
GUIDE PLATE:TRANSPORT:ASS'Y

35.M0122715
GUIDE PLATE:TRA
NSPORT:UPPER



42.M0122740
GUIDE PLATE:TRA
NSPORT:ASS'Y

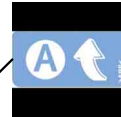
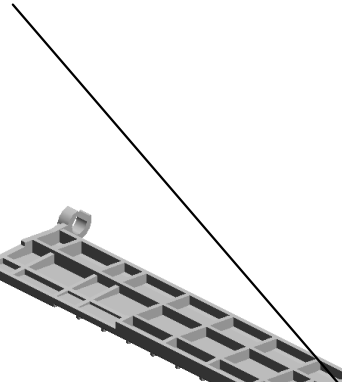

45.M0122743
DECAL:GUIDE PLA
TE:TRANSPORT:U
PPER

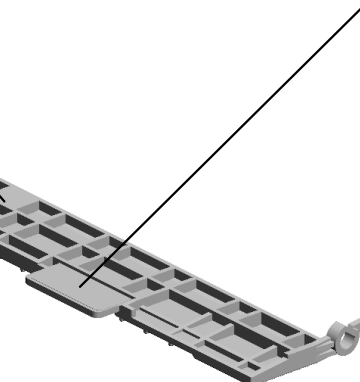

U001	U002	U003	U004	U005	U006	U007	U008	U009	U010	U011	U012	U013	U014
------	------	------	------	------	------	------	------	------	------	------	------	------	------

U006
PCU

1·M0121089
(x18)
GUIDE:PAPER:LEA
DING EDGE

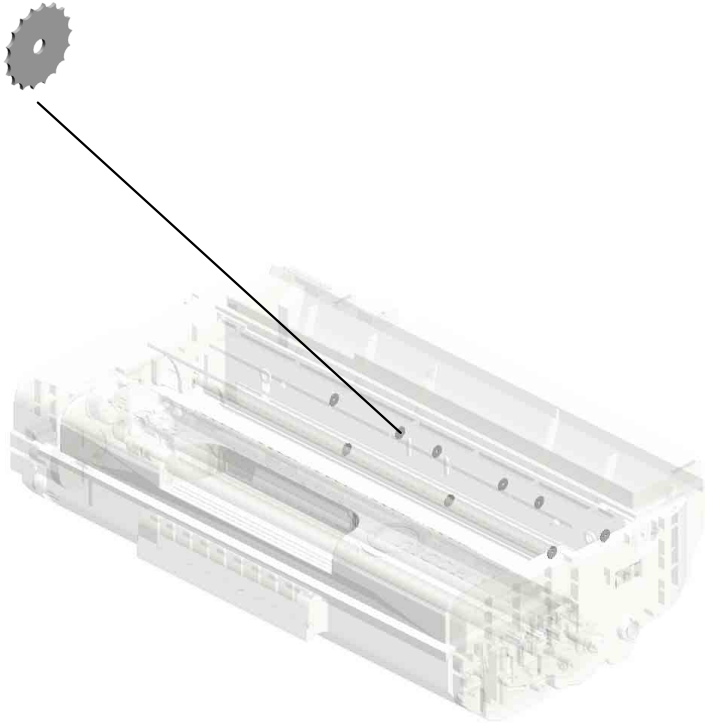
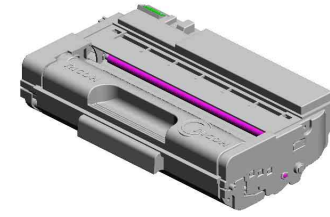

U001	U002	U003	U004	U005	U006	U007	U008	U009	U010	U011	U012	U013	U014
------	------	------	------	------	-------------	------	------	------	------	------	------	------	------

U007 TRANSFER/SEPARATION

4.M0126256 ROLLER:POSITIONING:TRANSFER ROLLER
1.M0126252 (x2) BUSHING:TRANSFER ROLLER:RIGHT
6.M1016250 TRANSFER ROLLER

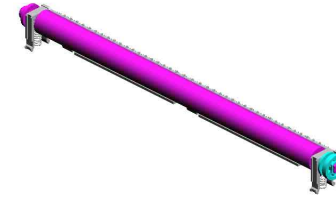

2.M0126254 (x2) SPRING:TRANSFER ROLLER

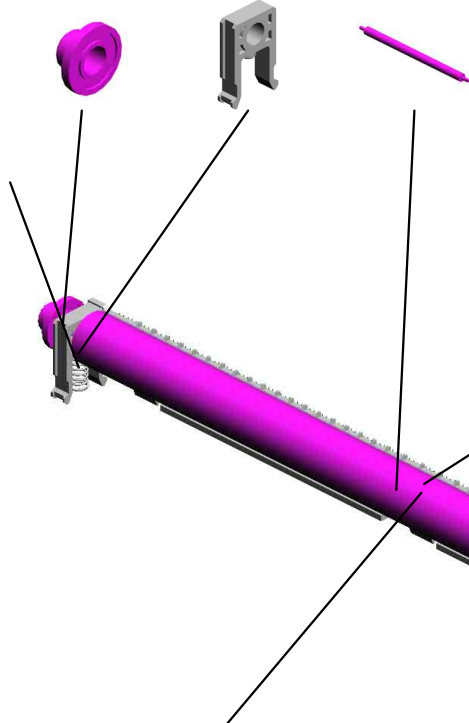

7.M1016259 ELECTRODE PLATE:SEPARATION

3.M0126255 GEAR:TRANSFER ROLLER

5.M0126260 COVER:ELECTRODE PLATE

U001	U002	U003	U004	U005	U006	U007	U008	U009	U010	U011	U012	U013	U014
------	------	------	------	------	------	------	------	------	------	------	------	------	------

U008.FUSING

U008 S001
MOC34003
(EU/AA):FUSING UNIT:ASS'Y

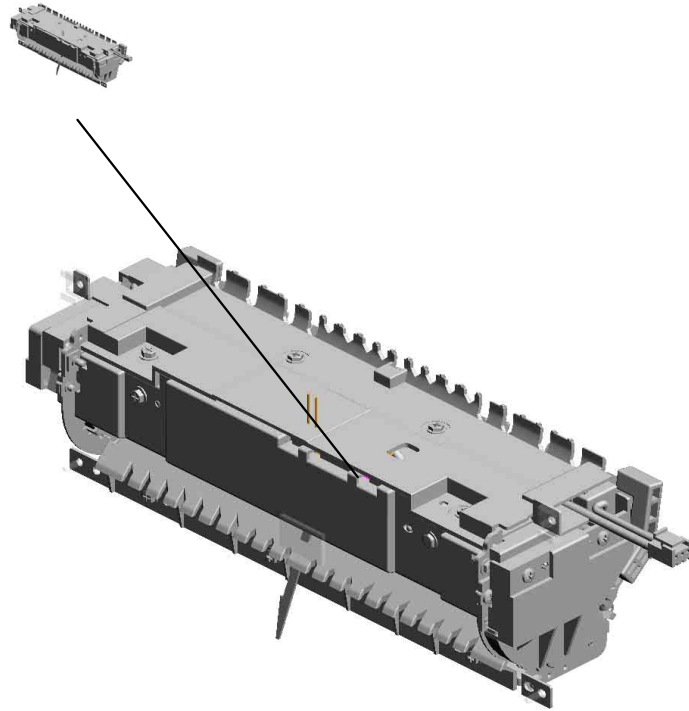

U001	U002	U003	U004	U005	U006	U007	U008	U009	U010	U011	U012	U013	U014
------	------	------	------	------	------	------	-------------	------	------	------	------	------	------

U008 FUSING

37.M0124699
DECAL:WARNING (HIGH TEMPERATURE):FRONT

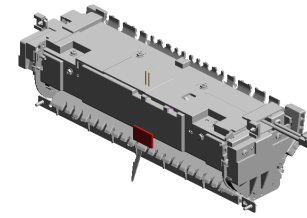

2.04503010N
(x2)
TAPPING SCREW - M3X10

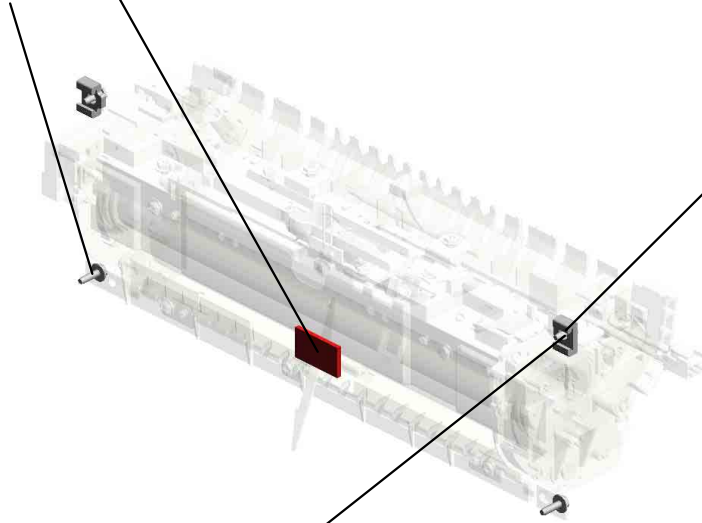

4.04513008N
(x2)
TAPPING SCREW - M3X8



29.M0124270
(x2)
THERMAL INSULATING BUSHING:FUSING UNIT



U001	U002	U003	U004	U005	U006	U007	U008	U009	U010	U011	U012	U013	U014
------	------	------	------	------	------	------	-------------	------	------	------	------	------	------

U008_S001
(EU/AA):FUSING UNIT:ASS'Y

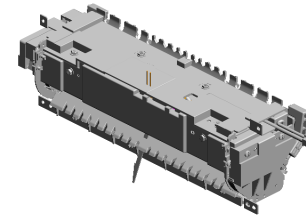

49.M0C34003
(EU/AA):FUSING U
NIT:ASS'Y

17.M0124186 COVER:LEFT UPPER:ASS'Y
7.07200040E (x2) RETAINING RING - M4
3.04513006N (x2) TAPPING SCREW - 3X6
21.M0124208 (x3) BRACKET:GATE PAWL
15.M0124120 (x3) TENSION SPRING: PICKOFF PAWL

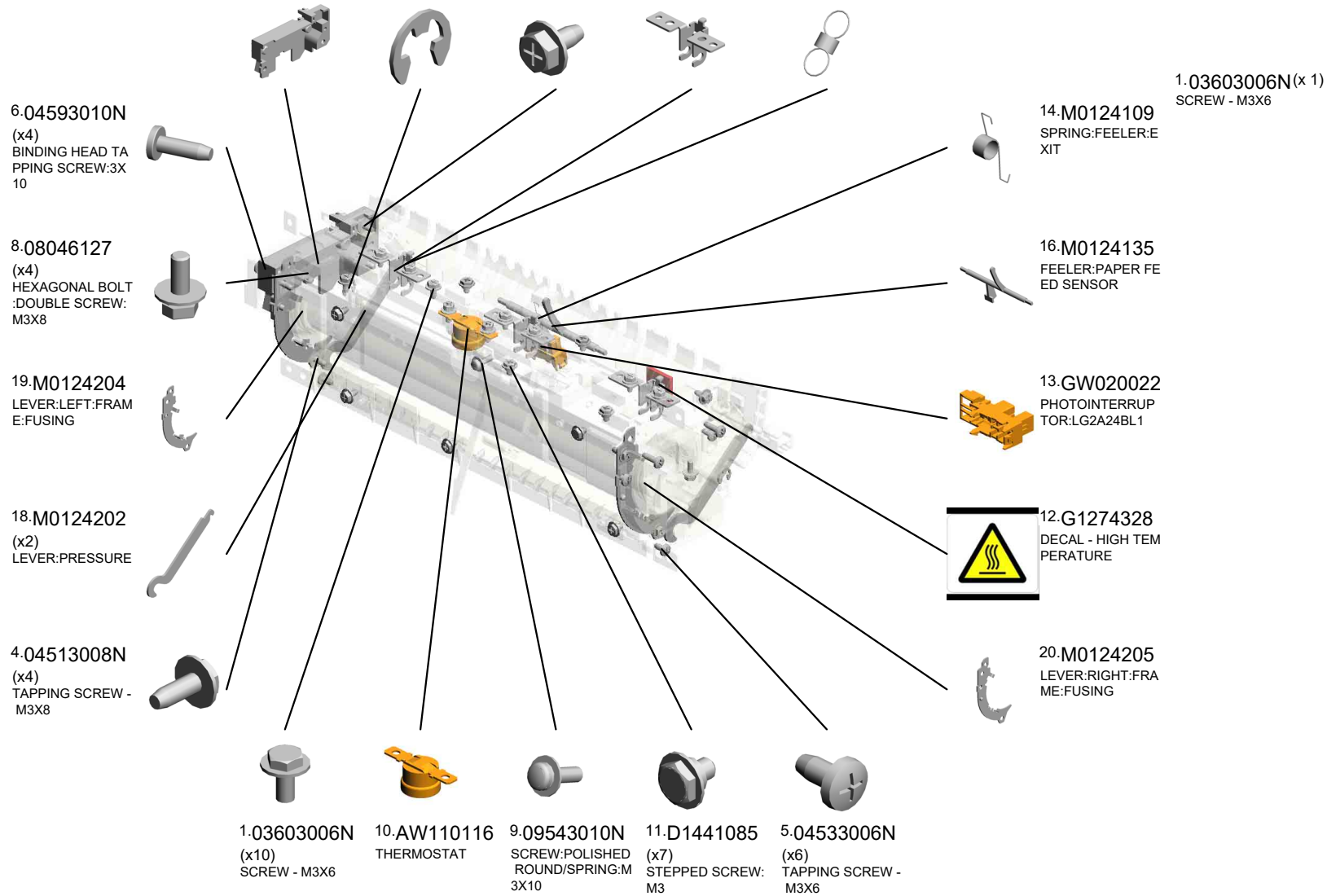

U008_S001
(EU/AA):FUSING UNIT:ASS'Y

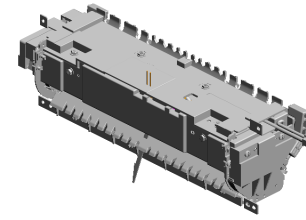

49.M0C34003
(EU/AA):FUSING U
NIT:ASSY

33.M0124285 LEVER:PRESSURE :RIGHT
27.M0124229 (x2) TENSION SPRING: FUSING:PRESSUR E
45.M2874263 THERMISTOR
35.M0124293 (x4) EXIT ROLLER:EXIT :FUSING
43.M0C34292 FUSING COVER:U PPER

41.M0C34240 HARNESS:THERM OSTAT

30.M0124276 COVER:LEFT:LOW ER:FUSING

44.M2874206 (x3) STRIPPER PAWLS

25.M0124216 (x2) TENSION SPRING: FUSING:GUIDE PL ATE

23.M0124212 FUSING ENTRANC E GUIDE PLATE:U PPER

26.M0124217 FUSING ENTRANC E GUIDE PLATE:LO WER
31.M0124279 CLEANING ROLLE R:ASSY
50.M0C34213 (EU/AA):HEATER:8 00W:230V
24.M0124215 GUIDE PLATE:EXIT
40.M0C34225 DISCHARGE BRUS H:HOT ROLLER

36.M0124603 DECAL:GUIDE PLA TE:B

32.M0124284 LEVER:PRESSURE :LEFT

34.M0124287 COVER:RIGHT UP PER:FUSING

28.M0124266 COVER:RIGHT LO WER:FUSING

22.M0124211 PLATE NUT:HEATE R

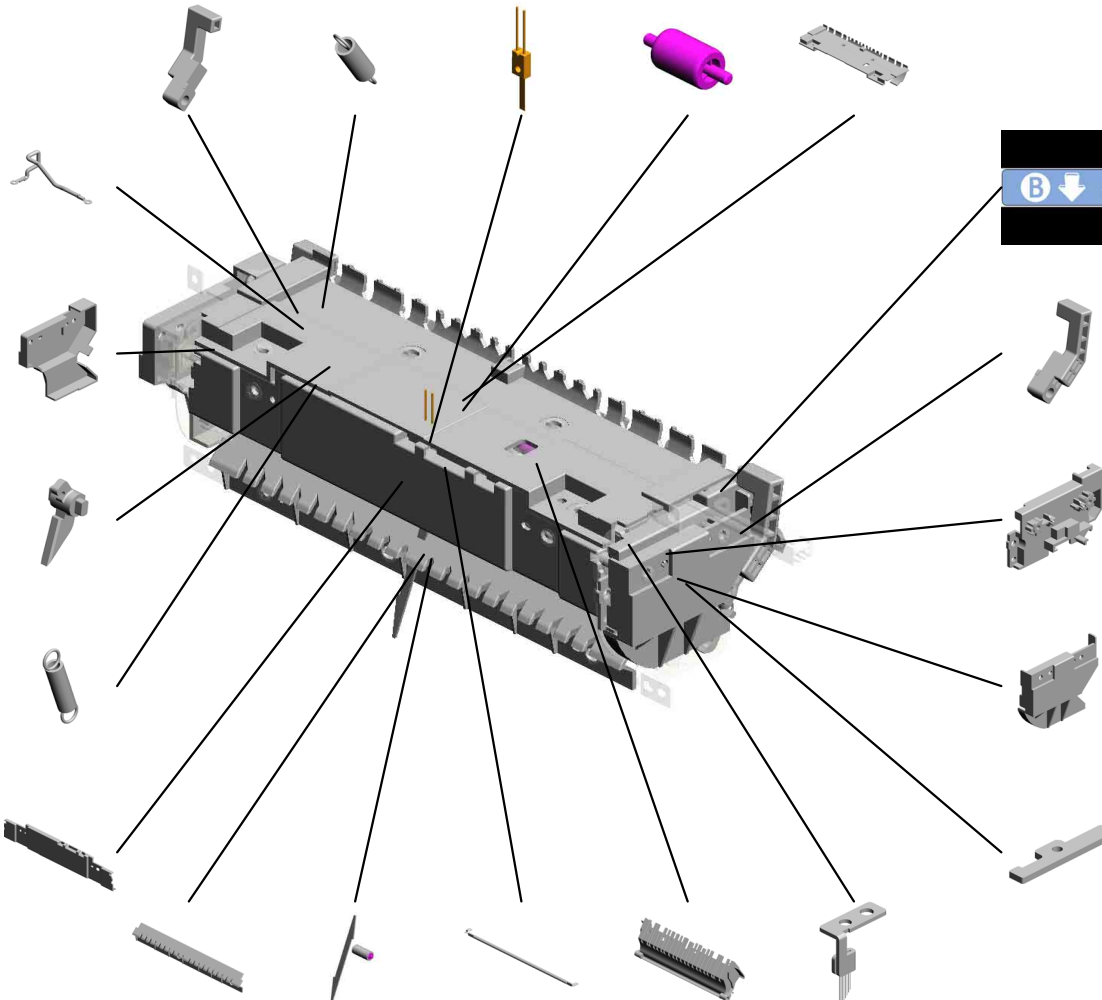

U008_S001
(EU/AA):FUSING UNIT:ASS'Y

51.M0C34238
(EU/AA):HARNESS:
FUSING

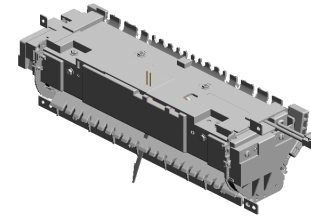

49.M0C34003
(EU/AA):FUSING U
NIT:ASS'Y

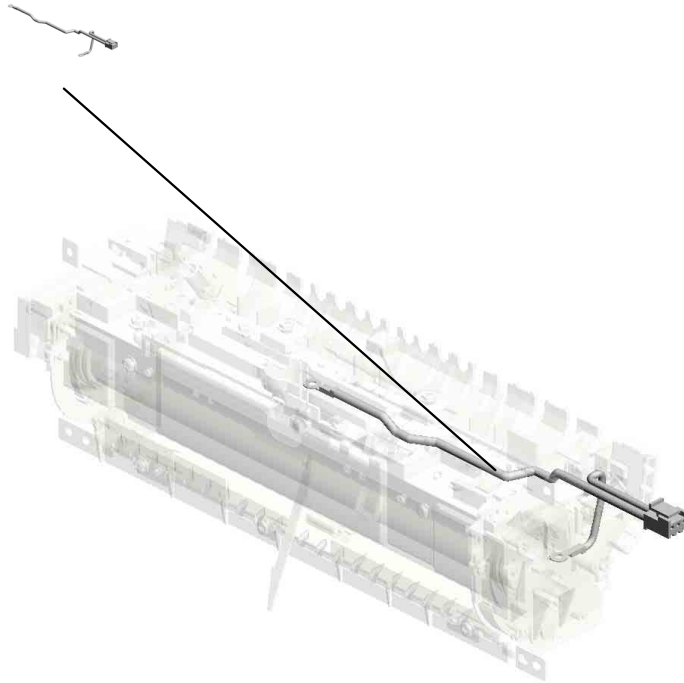

U001	U002	U003	U004	U005	U006	U007	U008	U009	U010	U011	U012	U013	U014
------	------	------	------	------	------	------	-------------	------	------	------	------	------	------

U009 PAPER EXIT

4.GA082014 (x2)
PLAIN SHAFT BEARING
RING:DIA6:DIA10:9

10.M0C34481
PLATE:LEFT:EXIT

9.M0C34470
EXIT ROLLER:DUPLICATE
LEX:ASSY

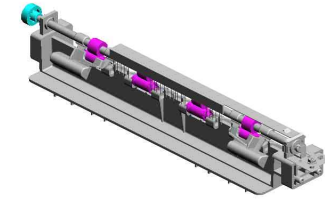

7.M0134455
GEAR:DRIVE:EXIT
ROLLER



3.07200040E (x2)
RETAINING RING - M4



1.04503008N (x2)
TAPPING SCREW - M3X8



6.M0124458
DISCHARGE BRUSH
H:EXIT:ASSY DRAWING



12.M0C34498
GROUND PLATE:EXIT
ROLLER

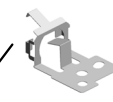

2.04543006Q
TAPPING SCREW - M3X6



5.M0124454 (x4)
SPRING:EXIT ROLLER:EXIT



8.M0C34454 (x4)
EXIT ROLLER



11.M0C34482
PLATE:RIGHT:EXIT



U001	U002	U003	U004	U005	U006	U007	U008	U009	U010	U011	U012	U013	U014
------	------	------	------	------	------	------	------	------	------	------	------	------	------

U010 DUPLEX

- 10.M0134610 GEAR:DRIVE:DUPL EX
- 3.04533006N (x2) TAPPING SCREW - M3X6
- 6.08050104 (x7) RETAINING RINGS -E:SILENCER:DIA4
- 4.04543006Q (x4) TAPPING SCREW - M3X6
- 16.M0134661 STOPPER:TRANSP ORT SUB-UNIT:DU PLEX

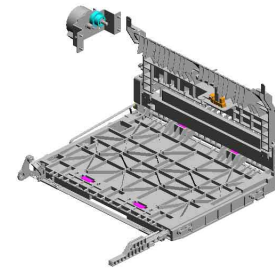

- 11.M0134611 BRACKET:DRIVE:DU PLEX:ASSY

- 2.04503010N (x2) TAPPING SCREW - M3X10

- 1.04503008N (x4) TAPPING SCREW - M3X8

- 7.08050106 RETAINING RINGS -E:SILENCER:DIA6

- 15.M0134635 SPRING:OPEN AND CLOSE:RIGHT

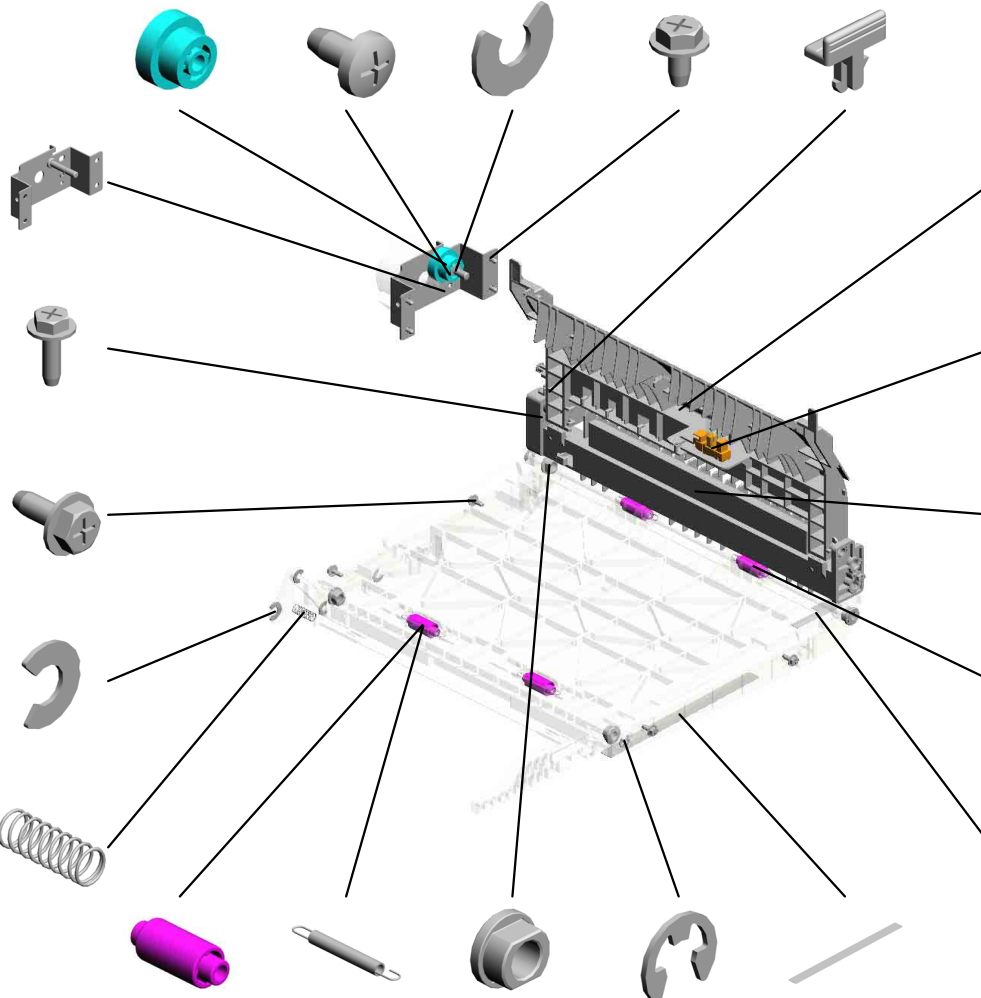

- 18.M0134664 GUIDE PLATE:VER TICAL TRANSPOR T:UPPER

- 8.GW020022 PHOTOINTERRUPTOR:LG2A24BL1

- 17.M0134663 GUIDE PLATE:VER TICAL TRANSPOR T:LOWER

- 13.M0134623 (x2) SPRING:EXIT

- 20.M0134671 SHEET:HORIZONTAL TRANSPORT:LEFT

- 12.M0134622 (x4) EXIT ROLLER:DUPLEX
- 14.M0134624 (x2) SPRING:EXIT:NO.2
- 9.M0124488 (x4) BUSHING:DIA6XDI A10X6
- 5.07200040E (x2) RETAINING RING - M4
- 19.M0134668 SHEET:GUIDE:HORIZONTAL TRANSPORT:LOWER

U010 DUPLEX

- 39.M01540265 STEPPER MOTOR
- 37.M0134794 DECAL:GUIDE PLATE:VERTICAL TRANSPORT:UPPER
- 26.M0134688 GROUND PLATE:HORIZONTAL TRANSPORT:REAR
- 33.M0134765 (x3) PULLEY:TRANSPORT
- 24.M0134684 SHEET:DUPLEX

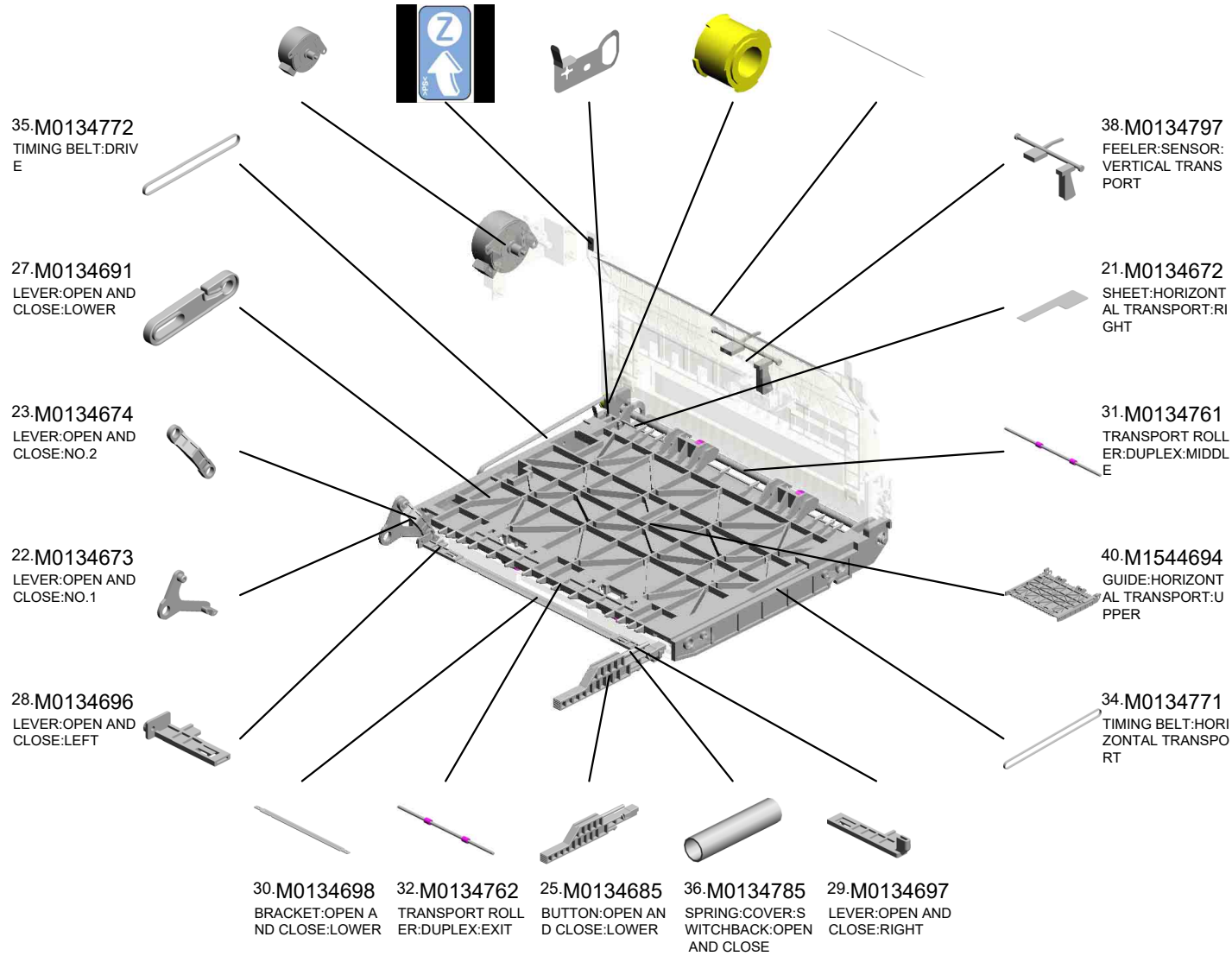
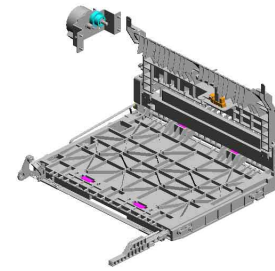

U001	U002	U003	U004	U005	U006	U007	U008	U009	U010	U011	U012	U013	U014
------	------	------	------	------	------	------	------	------	------	------	------	------	------

U010
DUPLEX

42.M2874719 (x2)
PIN:GUIDE:TRANS
PORT

41.M1544695
GUIDE:HORIZONT
AL TRANSPORT:L
OWER

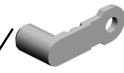
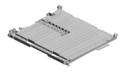
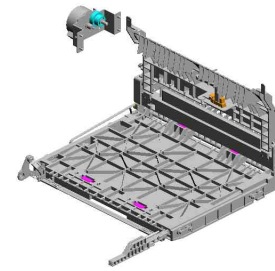

43.M2874895
(x4)
PIN:GUIDE:UPPER

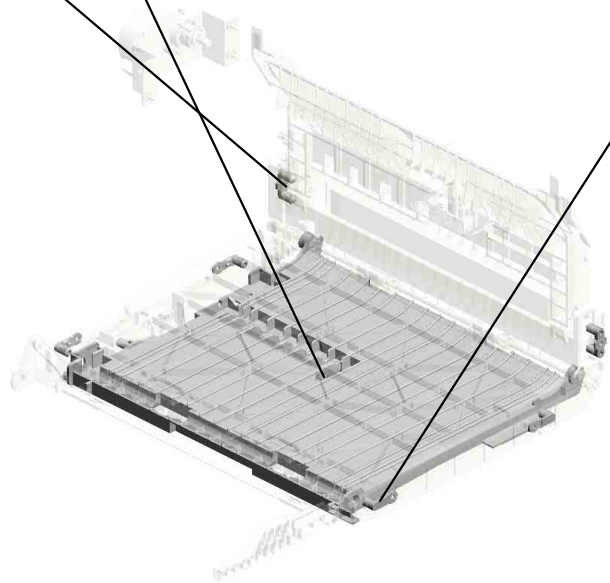

U001	U002	U003	U004	U005	U006	U007	U008	U009	U010	U011	U012	U013	U014
------	------	------	------	------	------	------	------	------	------	------	------	------	------

U011 MAIN DRIVE

10.M0121117 GEAR:DRIVE:DRUM
3.04543006Q TAPPING SCREW - M3X6
8.11050758 CLAMP:LWSM-030 6A
9.G0521120 SPRING - PAPER EXIT RELEASE
12.M0121120 GEAR:DRIVE:FUSION:NG:NO.3

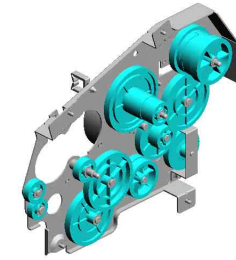

6.11050197
WIRE SADDLE



2.04513006N
(x4)
TAPPING SCREW - 3X6



13.M0121123
GEAR:DRIVE:PAPER FEED:NO.3

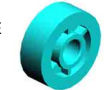

15.M0121172
GEAR:DRIVE:MANUAL FEED SECTION:NO.2



14.M0121171
GEAR:DRIVE:MANUAL FEED SECTION:NO.1



7.11050568
CLAMP:LWSS-0504



18.M0C31150
DC BRUSHLESS MOTOR:31.1W



19.M0C31177
CASE:DRIVE:ASSY



20.M1161118
GEAR:DRIVE:FUSION:NG:NO.1

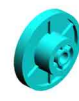

1.03603006N
(x6)
SCREW - M3X6

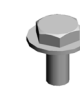

17.M0C31128
GEAR:DRIVE:FUSION:NG:NO.4



4.07200040E
RETAINING RING - M4



11.M0121119
GEAR:DRIVE:FUSION:NG:NO.2



5.08050104
(x6)
RETAINING RINGS - E.SILENCER:DIA4



16.M0131178
BRACKET:DRIVE:DUPLICATION



U011 MAIN DRIVE

22.M1161122
GEAR:DRIVE:PAPE
R FEED:NO.2

23.M1161124
GEAR:DRIVE:PAPE
R FEED:NO.4

24.M1171136
GEAR:DRIVE:DUPL
EX SECTION

21.M1161121
GEAR:DRIVE:PAPE
R FEED:NO.1

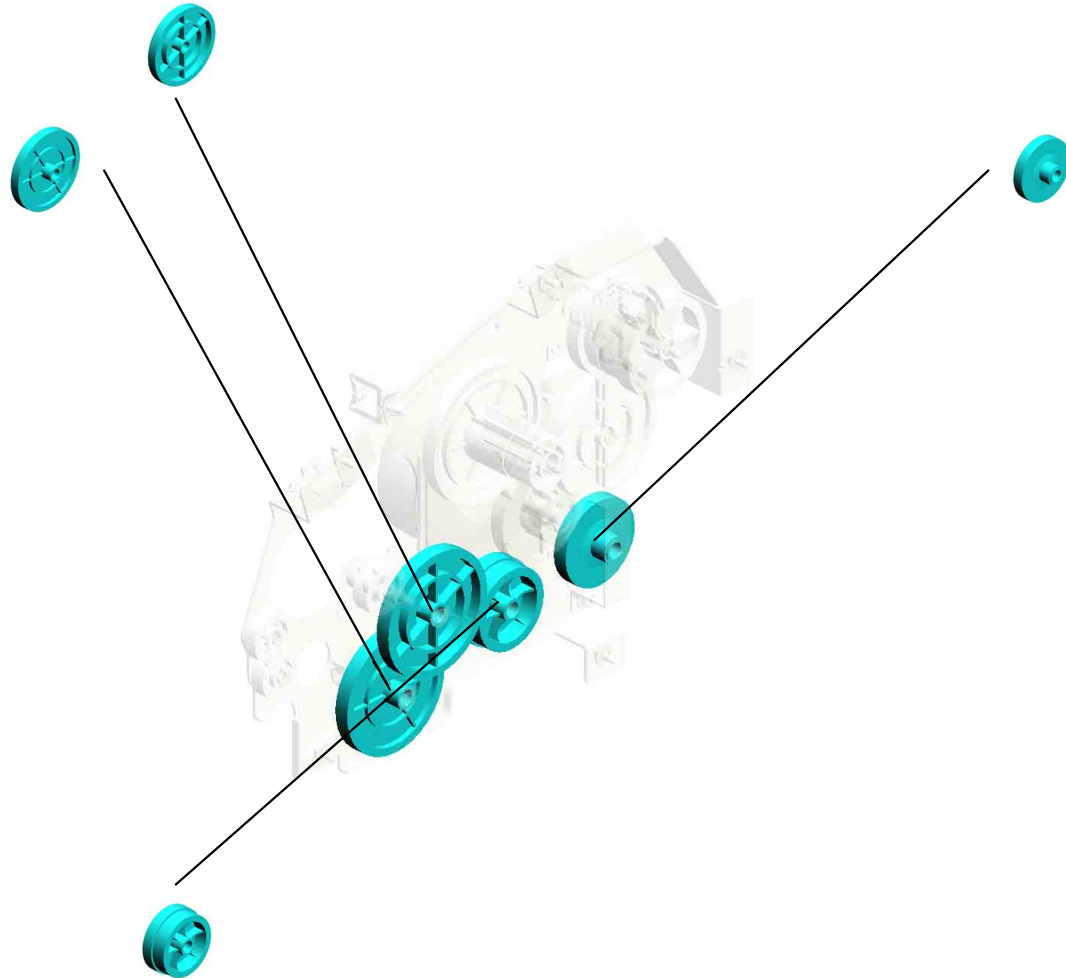
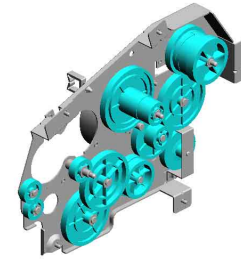

U001	U002	U003	U004	U005	U006	U007	U008	U009	U010	U011	U012	U013	U014
------	------	------	------	------	------	------	------	------	------	------	------	------	------

U012 ELECTRICAL

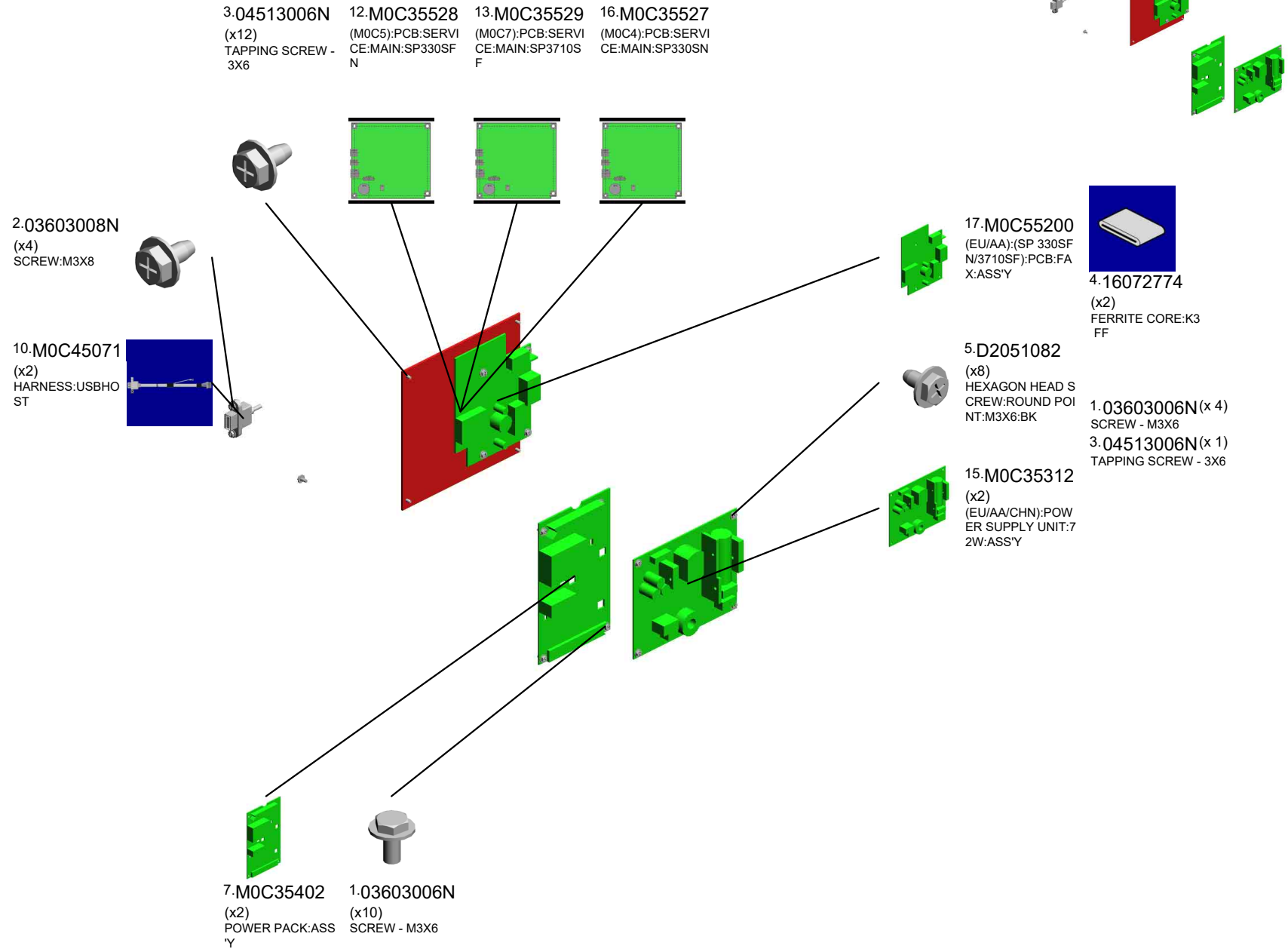

U001	U002	U003	U004	U005	U006	U007	U008	U009	U010	U011	U012	U013	U014
------	------	------	------	------	------	------	------	------	------	------	------	------	------

U013 MAIN FRAME

- 1.03603006N (x8) SCREW - M3X6
- 9.11050758 (x4) CLAMP:LWSM-030 6A
- 17.M0121037 (x2) TONER BOTTLE:C ASE
- 7.04543014Q (x2) TAPPING SCREW: 3X14
- 12.12042612 (x4) MICRO SWITCH:D3 V-16506-3C25

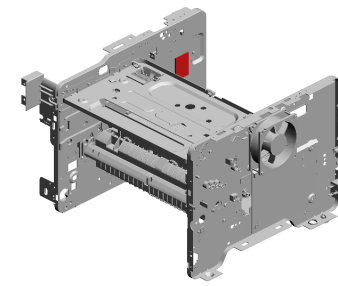

- 3.04513006N (x34) TAPPING SCREW - 3X6

- 4.04513014N (x2) TAPPING SCREW: 3X14

- 16.GW010007 (x2) PHOTO REFLECTI ON SENSOR:EXIT

- 8.11050568 (x4) CLAMP:LWSS-0504

- 2.04503008N (x12) TAPPING SCREW - M3X8

- 18.M0121040 (x2) CASE:DISCHARGE LAMP
- 15.G0271180 (x4) RUBBER FOOT - G F
- 21.M0121088 (x2) COIL SPRING:RAIL :RIGHT
- 19.M0121063 (x8) TERMINAL:CHARG E
- 20.M0121064 (x2) GROUND PLATE:O PC

- 10.11050760 (x6) CLAMP:LWSM-051 1A

- 6.04543006Q (x10) TAPPING SCREW - M3X6

- 14.AX640199 (x2) FAN:MM80:25MM:D C 2.16W

- 13.AA143592 (x2) SCREW- M4X6

- 5.04513030N (x4) TAPPING SCREW: 3X30

- 9.11050758 (x18) CLAMP:LWSM-030 6A
- 10.11050760 (x4) CLAMP:LWSM-051 1A

- 11.11050762 (x4) CLAMP:LWS-0711A

U013 MAIN FRAME

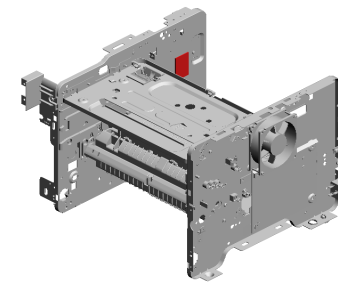

- 22.M0121089 (x6) GUIDE:PAPER:LEADING EDGE
- 23.M0121097 (x6) SUPPORTER:PAPER:TRANSPORT
- 24.M0124120 (x6) TENSION SPRING:PICKOFF PAWL
- 30.M0C34601 (x2) DECAL:LEVER:ENVELOPE:LEFT

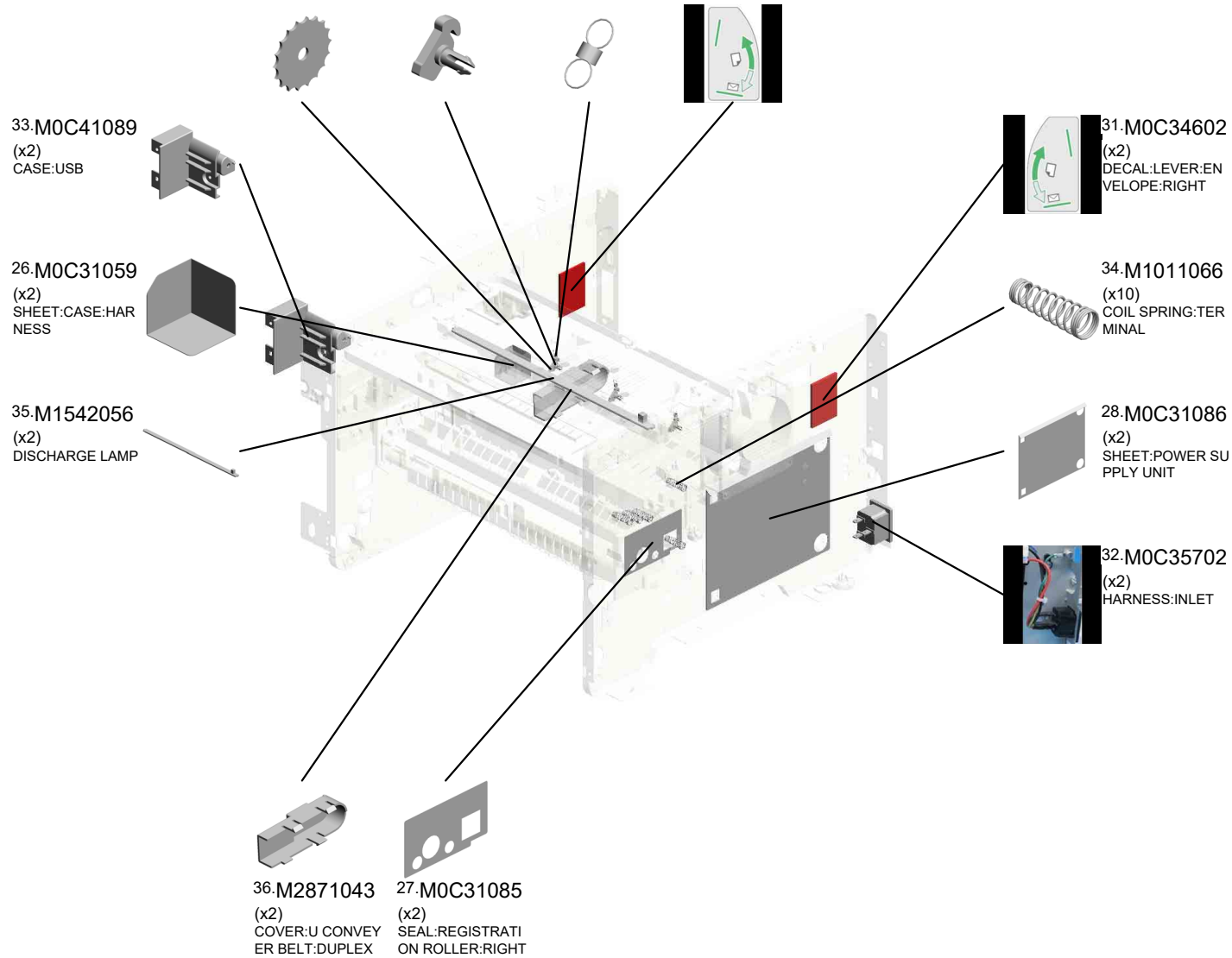

U014 ACCESSORIES

9.M01011301 (x3)
PLATE:LOGO:RIC

13.M0C50431 (SP 330SFN):MODEL NAME PLATE:NORMAL:4IN1

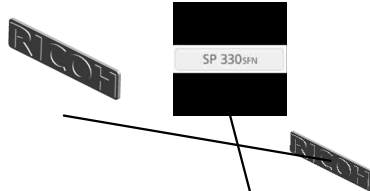

14.M0C70431 (NA/EU/AA):(SP 3710SF):MODEL NAME PLATE:EXTRAL:4IN1

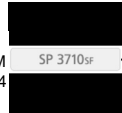

17.M0C40431 (SP 330SN):MODEL NAME PLATE:NORMAL:3IN1

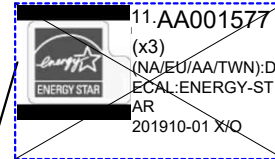
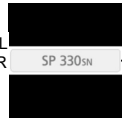

11.AA001577 (x3)
(NA/EU/AA/TWN):DECAL:ENERGY-STAR
201910-01 X/Q

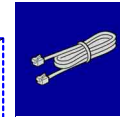

18.M0C55300 (x2)
(EU/AA/CHN):(SP 330SFN/3710SF):HARNESS:MODULER CORD

16. 11500491 (x 3)
(EU/AA):POWER SUPPLY CODE:250V:10A

Exclusive Parts

Number	Part Name	Group	ID
A1532117	ROLLER TERMINAL	U005	8
AA143592	SCREW- M4X6	U013	13
AW110116	THERMOSTAT	U008_S001	10
AX640199	FAN:MM80:25MM:DC 2.16W	U013	14
D0A42695	GRIP:PAPER TRAY	U005_S001	9
D1272514	ELECTROMAGNETIC CLUTCH:3.5 T:MANUAL FEED	U005	10
D1441085	STEPPED SCREW:M3	U005	11
		U008_S001	11
D2051082	HEXAGON HEAD SCREW:ROUND POINT:M3X6:BK	U012	5
D3ER1068	ROLLER:DETENT:PAPER TRAY	U005	12
D3ER1069	ROLLER:DETENT:PAPER TRAY:N O.2	U005	13
G0123050	SIDE FENCE GEAR	U005	14
G0201160	SNAP RING	U005	15
G0271180	RUBBER FOOT - GF	U013	15
G0292767	BY-PASS FEED COVER	U005	16
G0521120	SPRING - PAPER EXIT RELEASE	U011	9
G0521518	SPRING - LOCK LEVER	U001	9
G1022717	COVER:DC SOLENOID	U005	17
G1022789	STOPPER:PHOTOINTERRUPTOR	U005	18
G1271088	THERMISTOR	U004_S001	5
		U005	19
G1272627	PAPER FEED ROLLER - MM32	U005	20
G1274328	DECAL - HIGH TEMPERATURE	U008_S001	12
GA063084	COMPRESSION SPRING:AUXILIAR Y:SIDE FENCE	U005_S001	21
GA082014	PLAIN SHAFT BEARING:DIA6:DIA1 0:9	U009	4
GF013001	BOTTOM PLATE PAD	U005	22
		U005_S001	22
GW010007	PHOTO REFLECTION SENSOR:EXI T	U013	16
GW020022	PHOTOINTERRUPTOR:LG2A24BL1	U005	23
		U008_S001	13
		U010	8
M0121037	TONER BOTTLE:CASE	U013	17

Number	Part Name	Group	ID
M0121040	CASE:DISCHARGE LAMP	U013	18
M0121063	TERMINAL:CHARGE	U013	19
M0121064	GROUND PLATE:OPC	U013	20
M0121088	COIL SPRING:RAIL:RIGHT	U013	21
M0121089	GUIDE:PAPER:LEADING EDGE	U006	1
		U013	22
M0121097	SUPPORTER:PAPER:TRANSPORT	U013	23
M0121117	GEAR:DRIVE:DRUM	U011	10
M0121119	GEAR:DRIVE:FUSING:NO.2	U011	11
M0121120	GEAR:DRIVE:FUSING:NO.3	U011	12
M0121123	GEAR:DRIVE:PAPER FEED:NO.3	U011	13
M0121171	GEAR:DRIVE:MANUAL FEED SECT ION:NO.1	U011	14
M0121172	GEAR:DRIVE:MANUAL FEED SECT ION:NO.2	U011	15
M0122590	COIL SPRING:EARTH	U005_S001	24
M0122603	STOPPER:BASE PLATE	U005_S001	25
M0122605	FRICTION PAD:ADHESION	U005_S001	26
M0122612	COMPRESSION SPRING:TRAY BO TTOM PLATE	U005_S001	27
M0122613	COMPRESSION SPRING:SEPARAT ION	U005_S001	28
M0122631	CLOTH:EARTH:PAPER FEED	U005	29
M0122668	SHAFT:PAPER FEED:ASS'Y	U005	30
M0122701	ROLLER:INTERFACE:DRIVE	U005	31
M0122702	ROLLER:INTERFACE:DRIVEN	U005	32
M0122705	SPRING:ROLLER	U005	33
M0122711	BUSHING:REGISTRATION:DRIVEN :LEFT	U005	34
M0122715	GUIDE PLATE:TRANSPORT:UPPE R	U005_S002	35
M0122718	REGISTRATION ROLLER:DRIVE	U005	36
M0122719	REGISTRATION ROLLER:DRIVEN	U005	37
M0122722	SPRING:ROLLER:REGISTRATION	U005	38
M0122723	FEELER:REGISTRATION:SENSOR	U005	39
M0122725	SPRING:FEELER:REGISTRATION	U005	40
M0122730	BUSHING:REGISTRATION:DRIVEN :RIGHT	U005	41

Exclusive Parts

Number	Part Name	Group	ID
M0122740	GUIDE PLATE:TRANSPORT:ASS'Y	U005_S002	42
M0122741	GROUND PLATE:DRIVE:REGISTRATION ROLLER	U005	43
M0122742	GROUND PLATE:DRIVEN:REGISTRATION ROLLER	U005	44
M0122743	DECAL:GUIDE PLATE:TRANSPORT:UPPER	U005_S002	45
M0122744	GUIDE:REGISTRATION	U005	46
M0122745	GROUND PLATE:DRIVEN	U005	47
M0122753	BUSHING:ROLLER:DRIVEN	U005	48
M0122806	SHEET:GUIDE:MANUAL FEED SUB-UNIT	U005	49
M0122816	FRICTION PAD:HOLDER:MANUAL FEED:ASS'Y	U005	50
M0122824	FEELER:MANUAL FEED	U005	51
M0122830	MECHANICAL SPRING CLUTCH:MANUAL FEED	U005	52
M0122833	DECAL:SIDE FENCE:MANUAL FEED	U005	53
M0122860	PAPER FEED ROLLER:MANUAL FEED	U005	54
M0122874	COMPRESSION SPRING:MANUAL FEED	U005	55
M0122880	COMPRESSION SPRING:SEPARATION	U005	56
M0124109	SPRING:FEELER:EXIT	U008_S001	14
M0124120	TENSION SPRING:PICKOFF PAWL	U008_S001	15
		U013	24
M0124135	FEELER:PAPER FEED SENSOR	U008_S001	16
M0124186	COVER:LEFT UPPER:ASS'Y	U008_S001	17
M0124202	LEVER:PRESSURE	U008_S001	18
M0124204	LEVER:LEFT:FRAME:FUSING	U008_S001	19
M0124205	LEVER:RIGHT:FRAME:FUSING	U008_S001	20
M0124208	BRACKET:GATE PAWL	U008_S001	21
M0124211	PLATE NUT:HEATER	U008_S001	22
M0124212	FUSING ENTRANCE GUIDE PLATE:UPPER	U008_S001	23
M0124215	GUIDE PLATE:EXIT	U008_S001	24

Number	Part Name	Group	ID
M0124216	TENSION SPRING:FUSING:GUIDE PLATE	U008_S001	25
M0124217	FUSING ENTRANCE GUIDE PLATE:LOWER	U008_S001	26
M0124229	TENSION SPRING:FUSING:PRESSURE	U008_S001	27
M0124266	COVER:RIGHT LOWER:FUSING	U008_S001	28
M0124270	THERMAL INSULATING BUSHING:FUSING UNIT	U008	29
M0124276	COVER:LEFT:LOWER:FUSING	U008_S001	30
M0124279	CLEANING ROLLER:ASS'Y	U008_S001	31
M0124284	LEVER:PRESSURE:LEFT	U008_S001	32
M0124285	LEVER:PRESSURE:RIGHT	U008_S001	33
M0124287	COVER:RIGHT UPPER:FUSING	U008_S001	34
M0124293	EXIT ROLLER:EXIT:FUSING	U008_S001	35
M0124454	SPRING:EXIT ROLLER:EXIT	U009	5
M0124458	DISCHARGE BRUSH:EXIT:ASS'Y DRAWING	U009	6
M0124488	BUSHING:DIA6XDIA10X6	U005	57
		U010	9
M0124603	DECAL:GUIDE PLATE:B	U008_S001	36
M0124699	DECAL:WARNING (HIGH TEMPERATURE):FRONT	U008	37
M0126252	BUSHING:TRANSFER ROLLER:RIGHT	U007	1
M0126254	SPRING:TRANSFER ROLLER	U007	2
M0126255	GEAR:TRANSFER ROLLER	U007	3
M0126256	ROLLER:POSITIONING:TRANSFER ROLLER	U007	4
M0126260	COVER:ELECTRODE PLATE	U007	5
M0131178	BRACKET:DRIVE:DUPLEX	U011	16
M0134455	GEAR:DRIVE:EXIT ROLLER	U009	7
M0134610	GEAR:DRIVE:DUPLEX	U010	10
M0134611	BRACKET:DRIVE:DUPLEX:ASS'Y	U010	11
M0134622	EXIT ROLLER:DUPLEX	U010	12
M0134623	SPRING:EXIT	U010	13
M0134624	SPRING:EXIT:NO.2	U010	14
M0134635	SPRING:OPEN AND CLOSE:RIGHT	U010	15

Exclusive Parts

Number	Part Name	Group	ID
M0134661	STOPPER:TRANSPORT SUB-UNIT:DUPLIX	U010	16
M0134663	GUIDE PLATE:VERTICAL TRANSPORT:LOWER	U010	17
M0134664	GUIDE PLATE:VERTICAL TRANSPORT:UPPER	U010	18
M0134666	SHAFT:COVER:SWITCHBACK:OPEN AND CLOSE	U001	10
M0134667	SPRING:COVER:SWITCHBACK:OPEN AND CLOSE	U001	11
M0134668	SHEET:GUIDE:HORIZONTAL TRANSPORT:LOWER	U010	19
M0134671	SHEET:HORIZONTAL TRANSPORT:LEFT	U010	20
M0134672	SHEET:HORIZONTAL TRANSPORT:RIGHT	U010	21
M0134673	LEVER:OPEN AND CLOSE:NO.1	U010	22
M0134674	LEVER:OPEN AND CLOSE:NO.2	U010	23
M0134684	SHEET:DUPLIX	U010	24
M0134685	BUTTON:OPEN AND CLOSE:LOWER	U010	25
M0134688	GROUND PLATE:HORIZONTAL TRANSPORT:REAR	U010	26
M0134691	LEVER:OPEN AND CLOSE:LOWER	U010	27
M0134696	LEVER:OPEN AND CLOSE:LEFT	U010	28
M0134697	LEVER:OPEN AND CLOSE:RIGHT	U010	29
M0134698	BRACKET:OPEN AND CLOSE:LOWER	U010	30
M0134761	TRANSPORT ROLLER:DUPLIX:MIDDLE	U010	31
M0134762	TRANSPORT ROLLER:DUPLIX:EXIT	U010	32
M0134765	PULLEY:TRANSPORT	U010	33
M0134771	TIMING BELT:HORIZONTAL TRANSPORT	U010	34
M0134772	TIMING BELT:DRIVE	U010	35
M0134785	SPRING:COVER:SWITCHBACK:OPEN AND CLOSE	U010	36

Number	Part Name	Group	ID
M0134794	DECAL:GUIDE PLATE:VERTICAL TRANSPORT:UPPER	U010	37
M0134797	FEELER:SENSOR:VERTICAL TRANSPORT	U010	38
M0752610	COMPRESSION SPRING:LOCK:SIDE FENCE	U005_S001	58
M0C31059	SHEET:CASE:HARNESS	U013	26
M0C31085	SEAL:REGISTRATION ROLLER:RIGHT	U013	27
M0C31086	SHEET:POWER SUPPLY UNIT	U013	28
M0C31128	GEAR:DRIVE:FUSING:NO.4	U011	17
M0C31150	DC BRUSHLESS MOTOR:31.1W	U011	18
M0C31177	CASE:DRIVE:ASS'Y	U011	19
M0C31280	COVER:REAR	U001	12
M0C31281	COVER:REAR UPPER	U001	13
M0C31300	COVER:FRONT	U001	14
M0C31302	PAWL:BUTTON:RIGHT	U001	15
M0C31303	COMPRESSION SPRING:BUTTON:RIGHT	U001	16
M0C31370	COVER:REAR LOWER	U001	17
M0C31377	MAGNET CATCH:SCANNER:ASS'Y	U001	18
M0C31388	MAGNET CATCH:REAR:COVER:ASS'Y	U001	19
M0C31850	OPTICAL WRITING UNIT:ASS'Y	U004_S001	6
M0C32505	PAPER TRAY:ASS'Y	U005_S001	59
M0C32614	SPONGE:END FENCE	U005_S001	60
M0C32616	LEVER:PAPER VOLUME SENSOR	U005_S001	61
M0C32629	COVER:PAPER TRAY	U005_S001	62
M0C32672	RAIL:PAPER TRAY:LEFT	U005	63
M0C32673	RAIL:PAPER TRAY:RIGHT	U005	64
M0C32678	COMPRESSION SPRING:DETENT:PAPER TRAY	U005	65
M0C32681	DETENT:PAPER TRAY	U005	66
M0C32691	FEELER:PAPER END SENSOR	U005	91
M0C32804	GUIDE PLATE:UPPER:MANUAL FEED	U005	67
M0C32805	GUIDE PLATE:MANUAL FEED:LOWER	U005	68

Exclusive Parts

Number	Part Name	Group	ID
M0C32881	COVER:MANUAL FEED TABLE	U005	69
M0C34003	(EU/AA):FUSING UNIT:ASS'Y	U008_S001	49
M0C34213	(EU/AA):HEATER:800W:230V	U008_S001	50
M0C34225	DISCHARGE BRUSH:HOT ROLLER	U008_S001	40
M0C34238	(EU/AA):HARNESS:FUSING	U008_S001	51
M0C34240	HARNESS:THERMOSTAT	U008_S001	41
M0C34292	FUSING COVER:UPPER	U008_S001	43
M0C34454	EXIT ROLLER	U009	8
M0C34470	EXIT ROLLER:DUPLEX:ASS'Y	U009	9
M0C34481	PLATE:LEFT:EXIT	U009	10
M0C34482	PLATE:RIGHT:EXIT	U009	11
M0C34498	GROUND PLATE:EXIT ROLLER	U009	12
M0C34601	DECAL:LEVER:ENVELOPE:LEFT	U013	30
M0C34602	DECAL:LEVER:ENVELOPE:RIGHT	U013	31
M0C35312	(EU/AA/CHN):POWER SUPPLY UNIT:72W:ASS'Y	U012	15
M0C35402	POWER PACK:ASS'Y	U012	7
M0C35527	(M0C4):PCB:SERVICE:MAIN:SP330 SN	U012	16
M0C35528	(M0C5):PCB:SERVICE:MAIN:SP330 SFN	U012	12
M0C35529	(M0C7):PCB:SERVICE:MAIN:SP371 0SF	U012	13
M0C35702	HARNESS:INLET	U013	32
M0C40431	(SP 330SN):MODEL NAME PLATE:NORMAL:3IN1	U014	17
M0C41089	CASE:USB	U013	33
M0C41259	(SP 330SN):COVER:REAR MIDDLE:3IN1	U001	34
M0C41402	(EU/AA):(SP 330SN):OPERATION SUB-UNIT:4L:3IN1:ASS'Y	U002	5
M0C41600	(SP 330SN):SCANNER:ASS'Y	U003	2
M0C42632	DECAL:PICK-UP PAPER JAM	U001	20
M0C45071	HARNESS:USBHOST	U012	10
M0C50431	(SP 330SFN):MODEL NAME PLATE:NORMAL:4IN1	U014	13
M0C51250	COVER:UPPER:MFP	U001	21
M0C51255	COVER:SIDE PLATE:RIGHT	U001	22

Number	Part Name	Group	ID
M0C51257	EXTENSION TRAY:EXIT	U001	23
M0C51258	BUTTON:RIGHT	U001	24
M0C51259	(NA/EU/AA):(SP 330SFN/3710SF):COVER:REAR MIDDLE:4IN1	U001	25
M0C51264	EXTENSION TRAY:GUIDE	U001	26
M0C51266	(CHN[SP 330SN]/NA/EU/AA)::COVER:SIDE PLATE:LEFT	U001	27
M0C51267	EXTENSION TRAY:GUIDE:2	U001	28
M0C51402	(NA/EU/AA):(SP 330SFN/3710SF):OPERATION SUB-UNIT:4.3INCH:ASS'Y	U002	4
M0C51600	(SP 330SFN/3710SF):SCANNER:ASS'Y	U003	3
M0C51601	(SP 330SFN/3710SF):ARDF:ASS'Y	U003_S001	6
M0C55200	(EU/AA):(SP 330SFN/3710SF):PCB:FAX:ASS'Y	U012	17
M0C55300	(EU/AA/CHN):(SP 330SFN/3710SF):HARNESS:MODULER CORD	U014	18
M0C70431	(NA/EU/AA):(SP 3710SF):MODEL NAME PLATE:EXTRAL:4IN1	U014	14
M1011066	COIL SPRING:TERMINAL	U013	34
M1011301	PLATE:LOGO:RIC	U014	9
M1016250	TRANSFER ROLLER	U007	6
M1016259	ELECTRODE PLATE:SEPARATION	U007	7
M1092584	PRESSURE PLATE:SIDE FENCE:LEFT	U005_S001	70
M1092589	LEVER:LOCK:SIDE FENCE	U005_S001	71
M1092592	PAWL:LOCK:SIDE FENCE	U005_S001	72
M1161118	GEAR:DRIVE:FUSING:NO.1	U011	20
M1161121	GEAR:DRIVE:PAPER FEED:NO.1	U011	21
M1161122	GEAR:DRIVE:PAPER FEED:NO.2	U011	22
M1161124	GEAR:DRIVE:PAPER FEED:NO.4	U011	23
M1171136	GEAR:DRIVE:DUPLEX SECTION	U011	24
M1180501	(SP 330SFN/3710SF):SPEAKER:M118	U001	29
M1332710	SPRING:RELEASE:TRAY BOTTOM PLATE	U005_S001	73
M1341382	RAIL:SCANNER:OPEN AND CLOSE	U001	30

Exclusive Parts

Number	Part Name	Group	ID
M1341386	RAIL:STOPPER:SCANNER:OPEN AND CLOSE	U001	31
M1540265	STEPPER MOTOR	U010	39
M1542056	DISCHARGE LAMP	U013	35
M1542618	DECAL:PAPER TRAY:FRONT	U005_S001	74
M1542707	STAY:PAPER FEED	U005	75
M1542815	DECAL:FEED PAPER AGAIN:PREVENTION	U005	97
M1542831	DC SOLENOID:9.6W:24V	U005	76
M1542879	EXTENSION TRAY:MANUAL FEED	U005	77
M1544694	GUIDE:HORIZONTAL TRANSPORT:UPPER	U010	40
M1544695	GUIDE:HORIZONTAL TRANSPORT:LOWER	U010	41
M1561272	COIL SPRING:SCANNER	U001	32
M1561392	GUIDE PLATE:SCANNER:OPEN AND CLOSE	U001	33
M1561640	(SP 330SN):ADF:ASS'Y	U003_S002	8
M1562821	(SP 330SN):COVER:UPPER	U003_S002	9
M1562822	(SP 330SN):FRAME:PICKUP	U003_S002	10
M1562823	PICKUP ROLLER	U003_S002	11
M1562824	(SP 330SN):ARM:STOPPER	U003_S002	12
M1562826	(SP 330SN):COIL SPRING:PICKUP	U003_S002	13
M1562828	GEAR:28T	U003_S002	14
M1562829	(SP 330SN):PAWL:PICKUP	U003_S002	15
M1562830	(SP 330SN):FEED ROLLER	U003_S002	16
M1562832	(SP 330SN):SHAFT:TRANSPORT ROLLER:UPPER PAPER FEED	U003_S002	17
M1562833	ARM:ORIGINAL SENSOR	U003_S002	18
M1562834	(SP 330SN):SHAFT:PICKUP	U003_S002	19
M1562835	(SP 330SN):GEAR:28T	U003_S002	20
M1562836	(SP 330SN):COIL SPRING:FEED ROLLER:UPPER	U003_S002	21
M1562837	(SP 330SN):COIL SPRING:PAWL	U003_S002	22
M1562838	(SP 330SN):ORIGINAL SENSOR	U003_S002	23
M1562839	(SP 330SN):TRANSPORT ROLLER	U003_S002	24
M1562841	(SP 330SN):FRAME:ADF	U003_S002	25
M1562842	(SP 330SN):SEPARATION PAD:AS	U003_S002	26

Number	Part Name	Group	ID
	S'Y		
M1562843	(SP 330SN):SIDE FENCE:LEFT	U003_S002	27
M1562844	(SP 330SN):SIDE FENCE:RIGHT	U003_S002	28
M1562845	(SP 330SN):GROUND PLATE	U003_S002	29
M1562846	SCREW:3X4	U003_S002	30
M1562847	(SP 330SN):GEAR:21T	U003_S002	31
M1562848	(SP 330SN):GEAR:28T	U003_S002	32
M1562849	(SP 330SN):GEAR:37T	U003_S002	33
M1562850	(SP 330SN):GEAR:39T	U003_S002	34
M1562851	(SP 330SN):GEAR:46T	U003_S002	35
M1562852	(SP 330SN):GEAR:43T	U003_S002	36
M1562853	(SP 330SN):GEAR:53T	U003_S002	37
M1562854	(SP 330SN):GEAR:18T	U003_S002	38
M1562855	(SP 330SN):REGISTRATION SENSOR	U003_S002	39
M1562856	(SP 330SN):EXIT ROLLER	U003_S002	40
M1562857	PLAIN SHAFT BEARING:LEFT:EXIT ROLLER	U003_S002	41
M1562858	(SP 330SN):PLAIN SHAFT BEARING:RIGHT:EXIT ROLLER	U003_S002	42
M1562859	(SP 330SN):PLAIN SHAFT BEARING:LEFT:REGISTRATION ROLLER	U003_S002	43
M1562860	(SP 330SN):PLAIN SHAFT BEARING:RIGHT	U003_S002	44
M1562861	(SP 330SN):REGISTRATION ROLLER:ASS'Y	U003_S002	45
M1562862	(SP 330SN):ARM:REGISTRATION SENSOR	U003_S002	46
M1562863	(SP 330SN):FRAME:LOWER	U003_S002	47
M1562864	(SP 330SN):DISCHARGE BRUSH	U003_S002	48
M1562865	(SP 330SN):FRAME:MOTOR:ADF	U003_S002	49
M1562866	(SP 330SN):MOTOR:ADF	U003_S002	50
M1562868	(SP 330SN):COIL SPRING:PLATE:ADF	U003_S002	51
M1562869	(SP 330SN):PLATE:ADF	U003_S002	52
M1562871	(SP 330SN):COVER:ORIGINAL TRAY:EXTENSION TRAY:1	U003_S002	53
M1562872	(SP 330SN):COVER:ORIGINAL TRAY	U003_S002	54

Exclusive Parts

Number	Part Name	Group	ID
	Y:EXTENSION TRAY:2		
M1562881	(SP 330SN):COVER:MAIN	U003_S002	55
M1562882	(SP 330SN):COVER:MAIN:EXTENSION TRAY	U003_S002	56
M1562883	SCREW:3X10	U003_S002	57
M1562884	(SP 330SN):HINGE:LEFT:ASS'Y	U003_S002	58
M1562885	HINGE:RIGHT	U003_S002	59
M1562886	(SP 330SN):SHAFT:EXIT ROLLER	U003_S002	60
M1562887	(SP 330SN):EXIT ROLLER:DRIVEN	U003_S002	61
M1562888	(SP 330SN):SHAFT:PAPER FEED ROLLER:LOWER	U003_S002	62
M1562889	(SP 330SN):PAPER FEED ROLLER:LOWER	U003_S002	63
M1562890	(SP 330SN):COIL SPRING:REAR	U003_S002	64
M1562891	(SP 330SN):COVER:ADF:LOWER	U003_S002	65
M1562892	SCREW:3X8	U003_S002	66
M1562893	SPONGE:ADF	U003_S002	67
M1562894	(SP 330SN):COVER:REAR	U003_S002	68
M1562895	(SP 330SN):COVER:FRONT	U003_S002	69
M1562896	(SP 330SN):PAD:PICKUP	U003_S002	70
M1562898	SCREW:3X6	U003_S002	71
M1562899	(SP 330SN):SHEET:OUTLET	U003_S002	72
M2021779	(SP 330SN):DISCHARGE BRUSH:MECHANICAL SPRING CLUTCH	U003_S002	73
M2021780	(SP 330SN):GEAR:22T	U003_S002	74
M2021781	(SP 330SN):PAWL:MECHANICAL SPRING CLUTCH:M202	U003_S002	75
M2871043	COVER:U CONVEYER BELT:DUPLICATE	U013	36
M2872589	PAPER TRAY:REAR	U005_S001	78
M2872611	TRAY:BASE	U005_S001	79
M2872612	END FENCE	U005_S001	80
M2872615	SIDE FENCE:LEFT	U005_S001	81
M2872618	COVER:SIDE FENCE:LEFT	U005_S001	82
M2872620	SIDE FENCE:RIGHT	U005_S001	83
M2872622	COVER:SIDE FENCE:RIGHT	U005_S001	84
M2872623	PAWL:LOCK:END FENCE	U005_S001	85
M2872624	CLICK:SIDE FENCE	U005_S001	86

Number	Part Name	Group	ID
M2872625	LEVER:LOCK:EXTENSION TRAY	U005_S001	87
M2872626	DECAL:EXTENSION TRAY	U005_S001	88
M2872627	LEVER:LOCK:END FENCE	U005_S001	89
M2872636	GEAR:16Z	U005_S001	90
M2872875	SIDE FENCE:MANUAL FEED:RIGHT	U005	92
M2872876	SIDE FENCE:MANUAL FEED:LEFT	U005	93
M2872878	RACK:MANUAL FEED	U005	94
M2872879	COMPRESSION SPRING:SIDE FENCE:MANUAL FEED	U005	95
M2872881	BASE:MANUAL FEED TABLE	U005	96
M2874206	STRIPPER PAWLS	U008_S001	44
M2874263	THERMISTOR	U008_S001	45
M2874719	PIN:GUIDE:TRANSPORT	U010	42
M2874895	PIN:GUIDE:UPPER	U010	43
Note	See 2D parts catalog for the components of the ARDF.	U003_S001	7

Standard Parts



03603006N
SCREW - M3X6



03603008N
SCREW:M3X8



04503008N
TAPPING SCREW - M3X8



04503010N
TAPPING SCREW - M3X10



04503012N
TAPPING SCREW:3X12



04504008N
TAPPING SCREW - M4X8



04513006N
TAPPING SCREW - 3X6



04513008N
TAPPING SCREW - M3X8

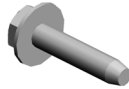

04513014N
TAPPING SCREW:3X14



04513030N
TAPPING SCREW:3X30

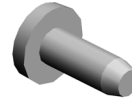

04523008N
(SP 330SFN/3710SF):TAPPING
G SCREW - M3X8



04523010N
BINDING SELF-TAPPING SC
REW:3X10



04533006N
TAPPING SCREW - M3X6



04543006Q
TAPPING SCREW - M3X6



04543008Q
TAPPING SCREW:3X8



04543014Q
TAPPING SCREW:3X14



04583010N
HEXAGON HEAD TAPPING S
CREW:3X10



04593010N
BINDING HEAD TAPPING SC
REW:3X10



07200040E
RETAINING RING - M4

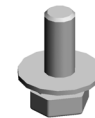

08046127
HEXAGONAL BOLT:DOUBLE
SCREW:M3X8



08050103
RETAINING RINGS-E:SILENC
ER:DIA3



08050104
RETAINING RINGS-E:SILENC
ER:DIA4



08050106
RETAINING RINGS-E:SILENC
ER:DIA6



09543010N
SCREW:POLISHED ROUND/
SPRING:M3X10



11050197
WIRE SADDLE



11050568
CLAMP:LWSS-0504



11050758
CLAMP:LWSM-0306A



11050760
CLAMP:LWSM-0511A

Standard Parts



11050761
CLAMP:LWS-0511A



11050762
CLAMP:LWS-0711A



11500491
(EU/AA):POWER SUPPLY CO
DE:250V:10A



12042612
MICRO SWITCH:D3V-16506-3
C25

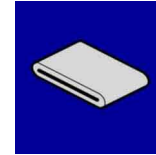

16072774
FERRITE CORE:K3 FF

Design Change List

Number	Title	Set	Old Part		New Part		Index No.		Q'ty	Interchg		Reason	Cut-in S/N
			P/N	Name	P/N	Name	Group	ID		Indiv.	Set		
202001-01	2001 Modification	-	M2872671	FEELER:PAPER END SENSOR	M0C32691	FEELER:PAPER END SENSOR	U005	91	1	O/O			
201910-01	1910 Modification	-	AA001577	(NA/EU/AA/TWN): DECAL:ENERGY- STAR			U014	11	1	X/O			
			AA001577	(NA/EU/AA/TWN): DECAL:ENERGY- STAR			U014	11	1	X/O			
			AA001577	(NA/EU/AA/TWN): DECAL:ENERGY- STAR			U014	11	1	X/O			
201810-01	1810 Modification	-	M2891601	(SP 330SFN/3710 SF):ARDF:ASS'Y	M0C51601	(SP 330SFN/3710 SF):ARDF:ASS'Y	U003_S001	6	1	O/O			

