



HP[®] and Canon[®] Color Universal Chip Chart

Visit us online for more information: www.scc-inc.com/ChipCenter/

It all starts with patented **universal** chips.
One chip. Multiple cartridges.



NOTE: When searching for a particular OEM SKU or printer model on this document, press the "CTRL" key and "F" key on your keyboard at the same time in order to search.

Updated 03-13-14

HP® and Canon® Color Universal Chip Chart

Static Control Product Code

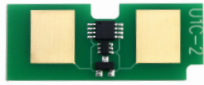
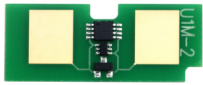
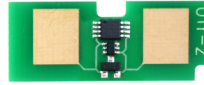
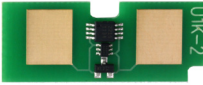
SSS™ 914	U1-2CHIP-C Chip Marking (U1C-2)		U1-2CHIP-MA Chip Marking (U1M-2)		U1-2CHIP-Y Chip Marking (U1Y-2)		U1-2CHIP-K Chip Marking (U1K-2)	
								
	Cyan		Magenta		Yellow		Black	
Printer Models	OEM SKU	Page Yield	OEM SKU	Page Yield	OEM SKU	Page Yield	OEM SKU	Page Yield
HP® 1500/2500	C9701A	4k	C9703A	4k	C9702A	4k	C9700A	5k
Canon® LBP-2410, MF8170c/8180c MFP	EP-87	4k	EP-87	4k	EP-87	4k	EP-87	5k
Canon® LBP-5200	CRG-101C CRG-301C CRG-701C	4k	CRG-101M CRG-301M CRG-701M	4k	CRG-101Y CRG-301Y CRG-701Y	4k	CRG-101BK CRG-301BK CRG-701BK	5k
HP® 2550, 2820/2840 MFP	Q3961A	4k	Q3963A	4k	Q3962A	4k	Q3960A	5k
HP® 3500/3550	Refer to U3-2CHIP-C		Refer to U3-2CHIP-MA		Refer to U3-2CHIP-Y		Q2670A	6k
HP® 3700	Q2681A	6k	Q2683A	6k	Q2682A	6k	Q2670A	6k

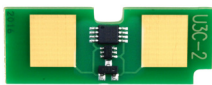
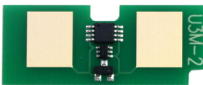
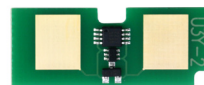
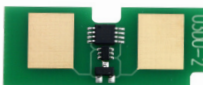



SSS™ 914	U3-2CHIP-C Chip Marking (U3C-2)		U3-2CHIP-MA Chip Marking (U3M-2)		U3-2CHIP-Y Chip Marking (U3Y-2)		U3-2CHIP-DU Chip Marking (U3DU-2)	
								
	Cyan		Magenta		Yellow		Drum Unit	
Printer Models	OEM SKU	Page Yield	OEM SKU	Page Yield	OEM SKU	Page Yield	OEM SKU	Page Yield
HP® 1500/2500 (Drum Unit)	Refer to U1-2CHIP-C		Refer to U1-2CHIP-MA		Refer to U1-2CHIP-Y		C9704A	20k
Canon® LBP-2410, MF8170c/8180c MFP (Drum Unit)							EP-87	20k
Canon® LBP-5200 (Drum Unit)							CRG-101 Drum CRG-301 Drum CRG-701 Drum	20k
HP® 2550, 2820/2840 MFP	Q3971A	2k	Q3973A	2k	Q3972A	2k	Q3964A	20k
HP® 3500/3550	Q2671A	4k	Q2673A	4k	Q2672A	4k	Refer to U1-2CHIP-K	

NOTE: Chip appearance subject to change. Pictures and images may not be reflective of current offering.







HP® and Canon® Color Universal Chip Chart

Static Control Product Code

SSS™ 914	U4-2CHIP-C Chip Marking (U4-2-C)		U4-2CHIP-MA Chip Marking (U4-2-MA)		U4-2CHIP-Y Chip Marking (U4-2-Y)		U4-2CHIP-K Chip Marking (U4-2-K)	
								
	Cyan		Magenta		Yellow		Black	
Printer Models	OEM SKU	Page Yield	OEM SKU	Page Yield	OEM SKU	Page Yield	OEM SKU	Page Yield
HP® 4600/4610/4650	C9721A (641A)	8k	C9723A (641A)	8k	C9722A (641A)	8k	C9720A (641A)	9k
Canon® LBP-2500/2510/5500	EP-85	8k	EP-85	8k	EP-85	8k	EP-85	9k
HP® 5500/5550	C9731A	12k	C9733A	12k	C9732A	12k	C9730A	13k
Canon® LBP-2710/2810/5700/5800, C3500	EP-86	12k	EP-86	12k	EP-86	12k	EP-86	13k
HP® 9500	C8551A	25k	C8553A	25k	C8552A	25k	C8550A	25k
HP® 9500 (Drum Unit)	C8561A	40k	C8563A	40k	C8562A	40k	C8560A	40k

Static Control Product Code

SSS™ 846	U14-2CHIP-C Chip Marking (U14C2)		U14-2CHIP-MA Chip Marking (U14M2)		U14-2CHIP-Y Chip Marking (U14Y2)		U14-2CHIP-K Chip Marking (U14K2)	
								
	Cyan		Magenta		Yellow		Black	
Printer Models	OEM SKU	Page Yield	OEM SKU	Page Yield	OEM SKU	Page Yield	OEM SKU	Page Yield
HP® 3600	Q6471A	4k	Q6473A	4k	Q6472A	4k	Refer to U15-2CHIP-K	
Canon® MF8450c MFP, MF9220/9280 MFP	CRG-117C CRG-317C CRG-717C	4k	CRG-117M CRG-317M CRG-717M	4k	CRG-117Y CRG-317Y CRG-717Y	4k		
HP® CP4005/4700*	CB401A	7.5k	CB403A	7.5k	CB402A	7.5k	CB400A	7.5k





*The HP® CP4005 cartridge can fit into the HP® 4700 with the correct toner load and chip will get 7.5k in the HP® 4700.

NOTE: Chip appearance subject to change. Pictures and images may not be reflective of current offering.



HP® and Canon® Color Universal Chip Chart

Static Control Product Code



SSS™ 846	U15-2CHIP-C Chip Marking (U15C2)		U15-2CHIP-MA Chip Marking (U15M2)		U15-2CHIP-Y Chip Marking (U15Y2)		U15-2CHIP-K Chip Marking (U15K2)	
								
	Cyan		Magenta		Yellow		Black	
Printer Models	OEM SKU	Page Yield	OEM SKU	Page Yield	OEM SKU	Page Yield	OEM SKU	Page Yield
HP® 1600/2600/2605, CM1015/1017 MFP	Q6001A (124A)	2k	Q6003A (124A)	2k	Q6002A (124A)	2k	Q6000A (124A)	2.5k
Canon® LBP-5000/5100	CRG-307C CRG-707C	2k	CRG-307M CRG-707M	2k	CRG-307Y CRG-707Y	2k	CRG-307BK CRG-707BK	2.5k
HP® 2700/3000	Q7561A	3.5k	Q7563A	3.5k	Q7562A	3.5k	Q7560A	6.5k
HP® 3600	Refer to U14-2CHIP-C		Refer to U14-2CHIP-MA		Refer to U14-2CHIP-Y		Q6470A	6k
Canon® MF8450c MFP							CRG-711BK	6k
Canon® MF8450c MFP, MF9220/9280 MFP							CRG-117BK CRG-317BK	6k
HP® 3800, CP3505	Q7581A	6k	Q7583A	6k	Q7582A	6k	Q6470A	6k
Canon® LBP-5300/5360/5400, MF9130/9150/9170; i-SENSYS® MF9220/9280 MFP	CRG-111C CRG-311C CRG-711C	6k	CRG-111M CRG-311M CRG-711M	6k	CRG-111Y CRG-311Y CRG-711Y	6k	CRG-111BK CRG-311BK CRG-711BK	6k
Canon® C1022 MFP	GPR-28C	6k	GPR-28M	6k	GPR-28Y	6k	GPR-28BK	6k
HP® 4700	Q5951A	10k	Q5953A	10k	Q5952A	10k	Q5950A	11k
HP® 4730 MFP	Q6461A	12k	Q6463A	12k	Q6462A	12k	Q6460A	12k



NOTE: Chip appearance subject to change. Pictures and images may not be reflective of current offering.

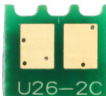
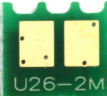

HP® and Canon® Color Universal Chip Chart

Static Control Product Code

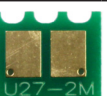
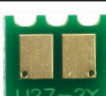
SSS™ 1014	U26-2CHIP-C Chip Marking (U26-2C)		U26-2CHIP-MA Chip Marking (U26-2M)		U26-2CHIP-Y Chip Marking (U26-2Y)		U26-2CHIP-K Chip Marking (U26-2K)	
								
	Cyan		Magenta		Yellow		Black	
Printer Models	OEM SKU	Page Yield	OEM SKU	Page Yield	OEM SKU	Page Yield	OEM SKU	Page Yield
HP® CP1215/1217/1515/1518, CM1312 MFP	CB541A (Intro)	.75k	CB543A (Intro)	.75k	CB542A (Intro)	.75k	CB540A (Intro)	.75k
Canon® LBP-5050, MF8030/8040/8050/8080 MFP	CRG-116C (Starter) CRG-316C (Starter) CRG-416C (Starter) CRG-716C (Starter)	.8k	CRG-116M (Starter) CRG-316M (Starter) CRG-416M (Starter) CRG-716M (Starter)	.8k	CRG-116Y (Starter) CRG-316Y (Starter) CRG-416Y (Starter) CRG-716Y (Starter)	.8k	CRG-116BK (Starter) CRG-316BK (Starter) CRG-416BK (Starter) CRG-716BK (Starter)	.8k
HP® CP2025, CM2320 MFP	CC531A (Intro)	1.2k	CC533A (Intro)	1.2k	CC532A (Intro)	1.2k	CC530A (Intro)	1.2k
Canon® LBP-7200/7600/7660/7680, MF8330/8340/8350/8360/8380 MFP	CRG-118C (Starter) CRG-318C (Starter) CRG-418C (Starter) CRG-718C (Starter)	1.4k	CRG-118M (Starter) CRG-318M (Starter) CRG-418M (Starter) CRG-718M (Starter)	1.4k	CRG-118Y (Starter) CRG-318Y (Starter) CRG-418Y (Starter) CRG-718Y (Starter)	1.4k	CRG-118BK (Starter) CRG-318BK (Starter) CRG-418BK (Starter) CRG-718BK (Starter)	1.2k
HP® CP3525, CM3530 MFP	Refer to U27-2CHIP-C		Refer to U27-2CHIP-MA		Refer to U27-2CHIP-Y		CE250A	5k
Canon® LBP-7700/7750							CRG-323BK (Starter) CRG-723BK (Starter)	5k
HP® CP5225	CE741A (307A)	7.3k	CE743A (307A)	7.3k	CE742A (307A)	7.3k	CE740A (307A)	7k
Canon® LBP-9100/9200/9500/9510/9600/9650	CRG-322C	7.5k	CRG-322M	7.5k	CRG-322Y	7.5k	CRG-322BK	6.5k

SSS™ 1014	U27-2CHIP-C Chip Marking (U27-2C)		U27-2CHIP-MA Chip Marking (U27-2M)		U27-2CHIP-Y Chip Marking (U27-2Y)		U27-2CHIP-K Chip Marking (U27-2K)	
								
	Cyan		Magenta		Yellow		Black	
Printer Models	OEM SKU	Page Yield	OEM SKU	Page Yield	OEM SKU	Page Yield	OEM SKU	Page Yield
HP® CP1215/1217/1515/1518, CM1312 MFP	CB541A	1.4k	CB543A	1.4k	CB542A	1.4k	CB540A	2.2k
Canon® LBP-5050, MF8030/8040/8050/8080 MFP	CRG-116C (Starter) CRG-316C (Starter) CRG-416C (Starter) CRG-716C (Starter)	1.5k	CRG-116M (Starter) CRG-316M (Starter) CRG-416M (Starter) CRG-716M (Starter)	1.5k	CRG-116Y (Starter) CRG-316Y (Starter) CRG-416Y (Starter) CRG-716Y (Starter)	1.5k	CRG-116BK (Starter) CRG-316BK (Starter) CRG-416BK (Starter) CRG-716BK (Starter)	2.3k
HP® CP1525, CM1415 MFP	CE321A (128A)	1.3k	CE323A (128A)	1.3k	CE322A (128A)	1.3k	CE320A (128A)	2k
HP® CP2025, CM2320 MFP	CC531A	2.8k	CC533A	2.8k	CC532A	2.8k	CC530A	3.5k
Canon® LBP-7200/7600/7660/7680, MF8330/8340/8350/8360/8380 MFP	CRG-118C (Starter) CRG-318C (Starter) CRG-418C (Starter) CRG-718C (Starter)	2.9k	CRG-118M (Starter) CRG-318M (Starter) CRG-418M (Starter) CRG-718M (Starter)	2.9k	CRG-118Y (Starter) CRG-318Y (Starter) CRG-418Y (Starter) CRG-718Y (Starter)	2.9k	CRG-118BK (Starter) CRG-318BK (Starter) CRG-418BK (Starter) CRG-718BK (Starter)	3.4k
HP® CP3525, CM3530 MFP	CE251A	7k	CE253A	7k	CE252A	7k	CE250X	10.5k
Canon® LBP-5460	GPR-29 TNC	8.5k	GPR-29 TNM	8.5k	GPR-29 TNY	8.5k	GPR-29 H	10k
Canon® LBP-7700/7750	CRG-323C CRG-723C	8.5k	CRG-323M CRG-723M	8.5k	CRG-323Y CRG-723Y	8.5k	CRG-323IBK CRG-723HBK	10k
HP® CP5525, M750	CE271A (650A)	15k	CE273A (650A)	15k	CE272A (650A)	15k	CE270A (650A)	13.5k
Canon® LBP-9100/9200/9500/9510/9600/9650	CRG-322IIC	15k	CRG-322IIM	15k	CRG-322IY	15k	CRG-322IIBK	13k

NOTE: Chip appearance subject to change. Pictures and images may not be reflective of current offering.



HP® and Canon® Color Universal Chip Chart

Static Control Product Code

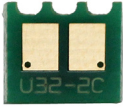
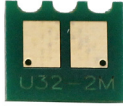
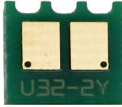
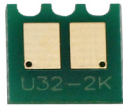
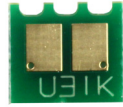



SSS™ 1014	U32-2CHIP-C Chip Marking (U32-2C)		U32-2CHIP-MA Chip Marking (U32-2M)		U32-2CHIP-Y Chip Marking (U32-2Y)		U32-2CHIP-K Chip Marking (U32-2K)		U31CHIP-K Chip Marking (U31K)	
										
	Cyan		Magenta		Yellow		Black		Black	
Printer Models	OEM SKU	Page Yield	OEM SKU	Page Yield	OEM SKU	Page Yield	OEM SKU	Page Yield	OEM SKU	Page Yield
HP® 100 M175 MFP, 200 M275 MFP, CP1025	CE311A (126A)	1k	CE313A (126A)	1k	CE312A (126A)	1k	CE310A (126A)	1.2k	N/A	N/A
Canon® LBP-7010c/7016c/ 7018c	CRG-329C CRG-729C	1k	CRG-329M CRG-729M	1k	CRG-329Y CRG-729Y	1k	CRG-329BK CRG-729BK	1.2k	N/A	N/A
HP® 300 M351/300 M375 MFP, 400 M451/400 M475 MFP	CE411A (305A)	2.6k	CE413A (305A)	2.6k	CE412A (305A)	2.6k	CE410X (305X)	4k	CE410A (305A)	2.2k
HP® 500 M551, 500 M570, 500 M575 MFP	CE401A (507A)	6k	CE403A (507A)	6k	CE402A (507A)	6k	CE400X (507X)	11k	CE400A (507A)	5.5k
HP® CP1525, CM1415 MFP	CE321A (128A)	1.3k	CE323A (128A)	1.3k	CE322A (128A)	1.3k	CE320A (128A)	2k	N/A	N/A

NOTE: Chip appearance subject to change. Pictures and images may not be reflective of current offering.







HP® and Canon® Color Universal Chip Chart

Static Control Product Code

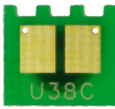
SSS™ 1014	U37-2CHIP-C Chip Marking (U37-2C)		U37-2CHIP-MA Chip Marking (U37-2M)		U37-2CHIP-Y Chip Marking (U37-2Y)		U37-2CHIP-K Chip Marking (U37-2K)	
								
	Cyan		Magenta		Yellow		Black	
Printer Models	OEM SKU	Page Yield	OEM SKU	Page Yield	OEM SKU	Page Yield	OEM SKU	Page Yield
HP® M176, M177 MFP	CF351A (HP 130A)	1k	CF353A (HP 130A)	1k	CF352A (HP 130A)	1k	CF350A (HP 130A)	1.3k
HP® 200 M251, 200 M276 MFP	CF211A	1.8k	CF213A	1.8k	CF212A	1.8k	CF210X	2.4k
HP® 700 M775 MFP	CE341A	16k	CE343A	16k	CE342A	16k	CE340A	13.5k
Canon® LBP-7100/7110c, MF8280c/MF8230	CRG-131C CRG-331C CRG-731C	1.5k	CRG-131MA CRG-331MA CRG-731MA	1.5k	CRG-131Y CRG-331Y CRG-731Y	1.5k	CRG-131II BK CRG-331II BK CRG-731II BK	2.4k
Canon® LBP-9520/9660	CRG-335CYN	16.5k	CRG-335MAG	16.5k	CRG-335YEL	16.5k	CRG-335BLK	13k

Static Control Product Code

SSS™ 1014	U38CHIP-C Chip Marking (U38C)		U38CHIP-MA Chip Marking (U38M)		U38CHIP-Y Chip Marking (U38Y)		U38CHIP-K Chip Marking (U38K)	
								
	Cyan		Magenta		Yellow		Black	
Printer Models	OEM SKU	Page Yield	OEM SKU	Page Yield	OEM SKU	Page Yield	OEM SKU	Page Yield
HP® 200 M251, 200 M276 MFP	CF211A (Intro)	.7k	CF213A (Intro)	.7k	CF212A (Intro)	.7k	CF210A (Intro)	.7k
HP® 300 M351, 300 M375 MFP; 400 M451, 400 M475 MFP	CE411A (Intro)	1.4k	CE413A (Intro)	1.4k	CE412A (Intro)	1.4k	CE410A (Intro)	1.4k

NOTE: Chip appearance subject to change. Pictures and images may not be reflective of current offering.

