

# Feed Component Guide

## for Canon Office Equipment

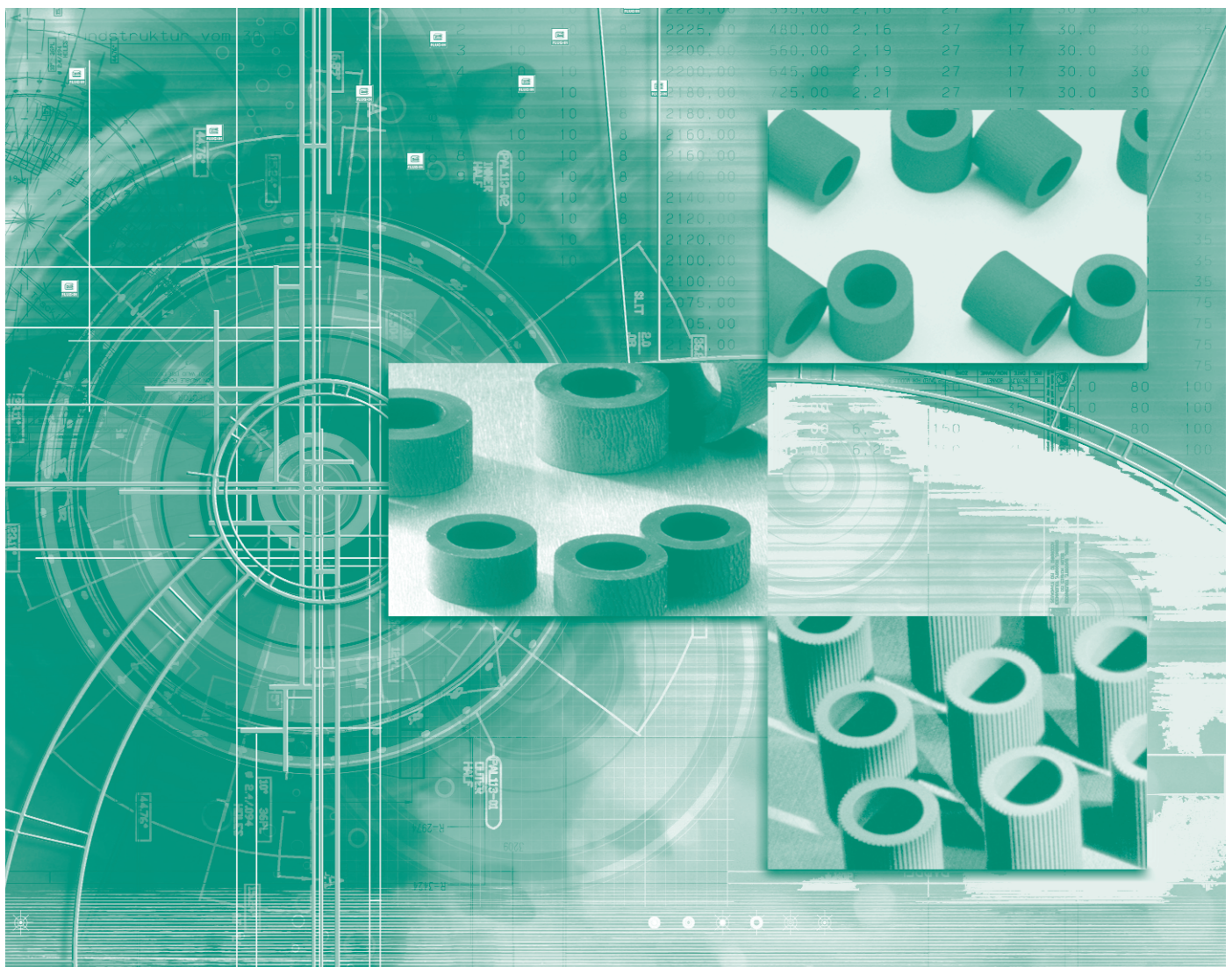

This guide is designed to help you order high quality, cost-effective Katun feed components for the Canon office equipment listed below. You can identify the correct Katun part number for a particular feed component in either of two ways:

1. Cross-reference Katun part numbers with the OEM part number for a given feed component.
2. Locate the feed component in the appropriate machine illustration and then reference its identification letter in the product listing.

<b>Canon Model</b>	<b>Page Number</b>
<b>CLC-700, 800, 900, 920, 950</b>	<b>4</b>
<b>CLC-1000/2400</b>	<b>6</b>
<b>GP-30, 55</b>	<b>8</b>
<b>GP-200, 200D, 200E, 200F, 200S, 210, 215, 220, 225 and imageRunner 200L, 210E, 210N, 210S</b>	<b>10</b>
<b>imageRunner 330E, 330S, 400, 400E, 400S</b>	<b>11</b>
<b>imageRunner 550/600</b>	<b>12</b>
<b>NP-3525, 3725</b>	<b>13</b>
<b>NP-3030, 3050</b>	<b>14</b>
<b>NP-4035, 4540</b>	<b>16</b>
<b>NP 4050, 4080</b>	<b>18</b>
<b>NP-4335, 4835</b>	<b>20</b>
<b>NP-6030, 6035</b>	<b>22</b>
<b>NP-6050</b>	<b>24</b>
<b>NP-6060</b>	<b>26</b>
<b>NP-6085</b>	<b>28</b>
<b>NP-6650</b>	<b>30</b>
<b>NP-8530</b>	<b>32</b>
<b>NP-8580</b>	<b>34</b>

*All Katun feed components are sold "tire only" unless otherwise noted.*

**Visit [www.katun.com](http://www.katun.com) for the most current cross-reference information and feed component pricing.**

## Installing Katun Feed Tires? Proper Installation Ensures Excellent Performance

Every "crepe-style" (textured surface) Katun feed tire is imprinted with a directional arrow. When installing, it is essential that the imprinted arrow points in the direction of required tire rotation. In certain machine applications, this may mean that the side for the tire that bears the imprinted arrow faces toward the technician; in other applications, the arrow side may face toward the rear of the machine.

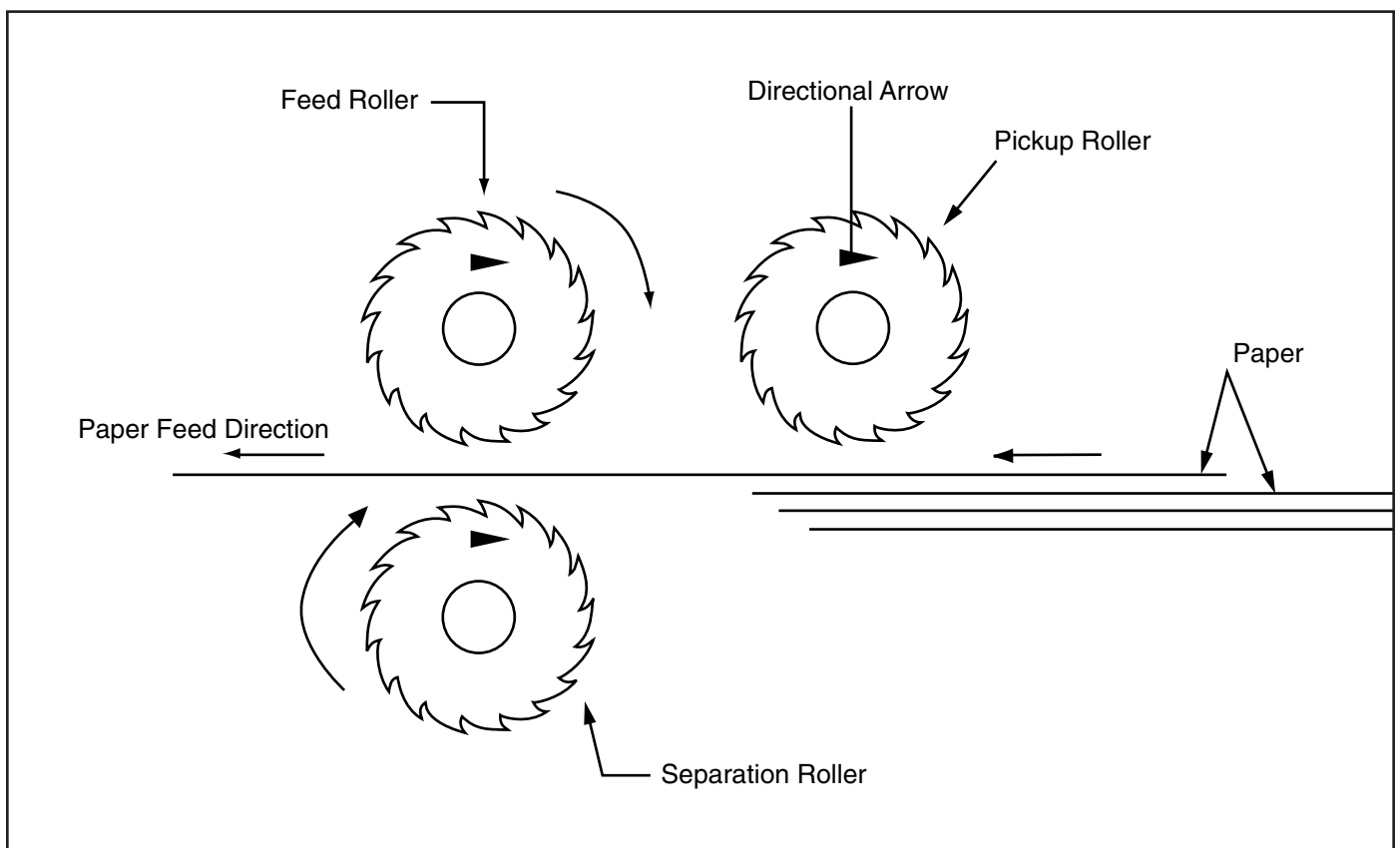

## Feed Component Care Tips

- *Keep bags sealed tightly until feed components will be installed.*
- *Store feed components in a cool, dry, and dark location.*
- *Clean feed components ONLY with soap and warm water.*

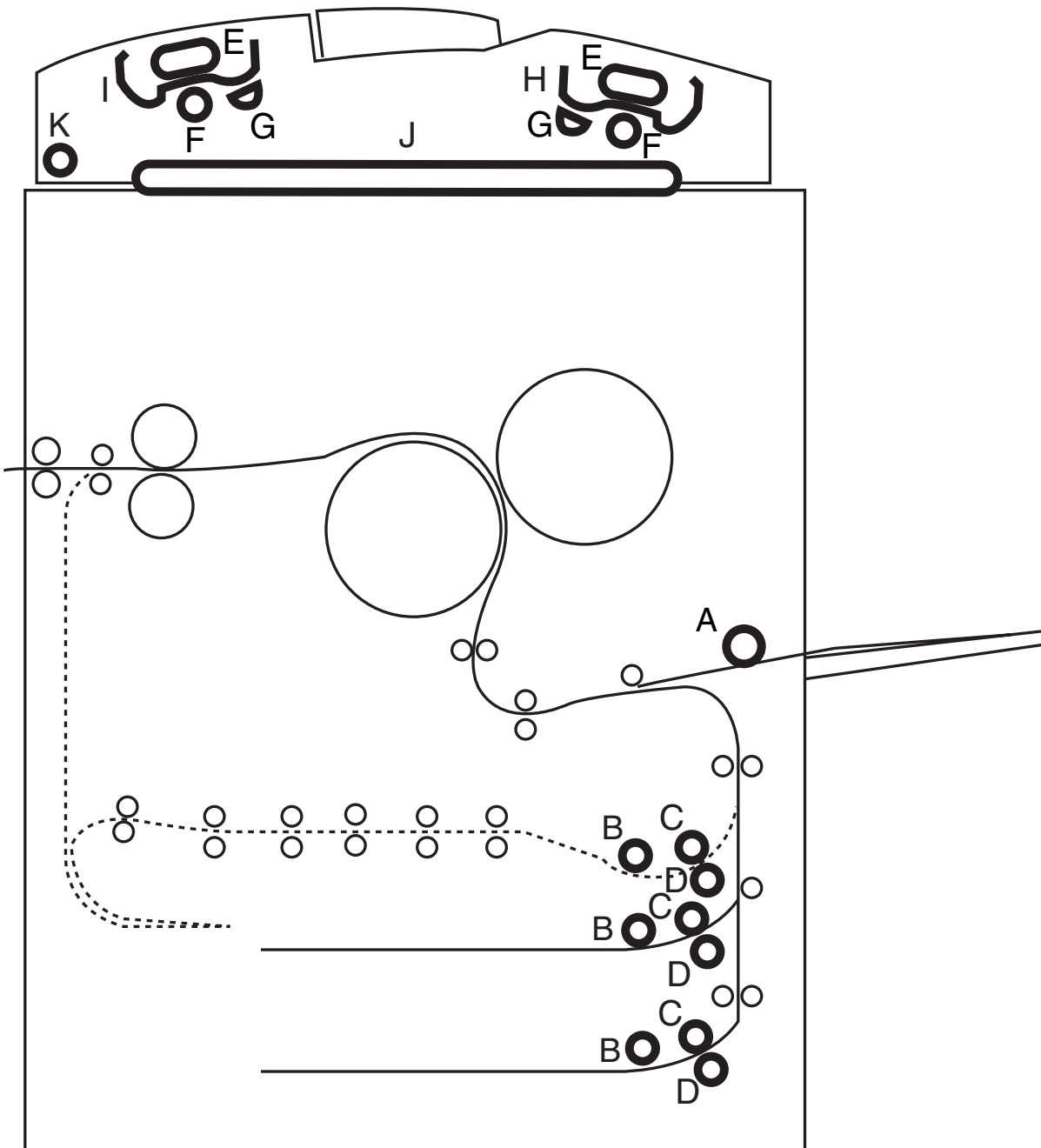

	Description	OEM PN	Katun PN
A	Manual Pickup Tire	FF5-2287-000	15012302
B	Pickup Roller	FF5-1220-000 FF5-1221-000	15017821
B	Paper Pickup Tire (not in CLC 700)	FB2-0846-000	15020761
B	Front Paper Pickup Tire	FF5-2101-000	15020761
B	Rear Paper Pickup Tire	FF5-2102-000	15020761
C	Feed Roller	FB1-7061-000	15011264
C	Feed Roller	FF5-2103-000	15020762
C	Paper Feed Tire (not in CLC 700)	FB2-0847-000	15020762
C	Feed Roller with hub assembly	FB1-7061-000	15016779
D	Separation Roller	FB1-7060-020	15012801
D	Separation Tire	FB2-0848-000	15017777
D	Separation Roller with hub assembly	FB1-7060-020	15016833
E	Separation Belt (RDF-E1)	FA5-5427-000	15015001
F	Feed Roller (RDF-E1)	FC2-1533-000	15013735
G	Pickup Roller (RDF-E1)	FC2-1532-000	15015611
H	Separation Flapper Right (RDF-E1)	FF3-0115-000	15017008
I	Separation Flapper Left (RDF-E1)	FF3-0117-000	15017009
J	Document Feed Belt (RDF-E1)	FC2-1210-000	15014560
K	Reverse Roller (RDF-E1)	FC2-1345-000	15021649

## REPLACEMENT KITS

	Description	Katun PN
	<b>Feed Roller Kit</b>	<b>15012619</b>
B	(4) Pickup Rollers	
C	(4) Feed Rollers	
D	(4) Separation Rollers	
	<b>250K Maintenance Kit (RDF-E1)</b>	<b>15018277</b>
E	(17) Separation Belts	
F	(22) Feed Rollers	
G	(4) Pickup Rollers	
H	(2) Separation Flappers Right	
I	(3) Separation Flappers Left	
J	(1) Document Feed Belt	

## ADDITIONAL KATUN PARTS

Description	OEM PN	Katun PN
Bearing	XG9-0013-000	15576204
Bearing	XG9-0208-000	15576204
Bearing	XG9-0249-000	15576204
Corona Wire Spring	97-5527-000	15524647
Upper Fuser Roller	FB4-6597-000	15022701
Lower Fuser Roller	FB4-6598-000	15022702

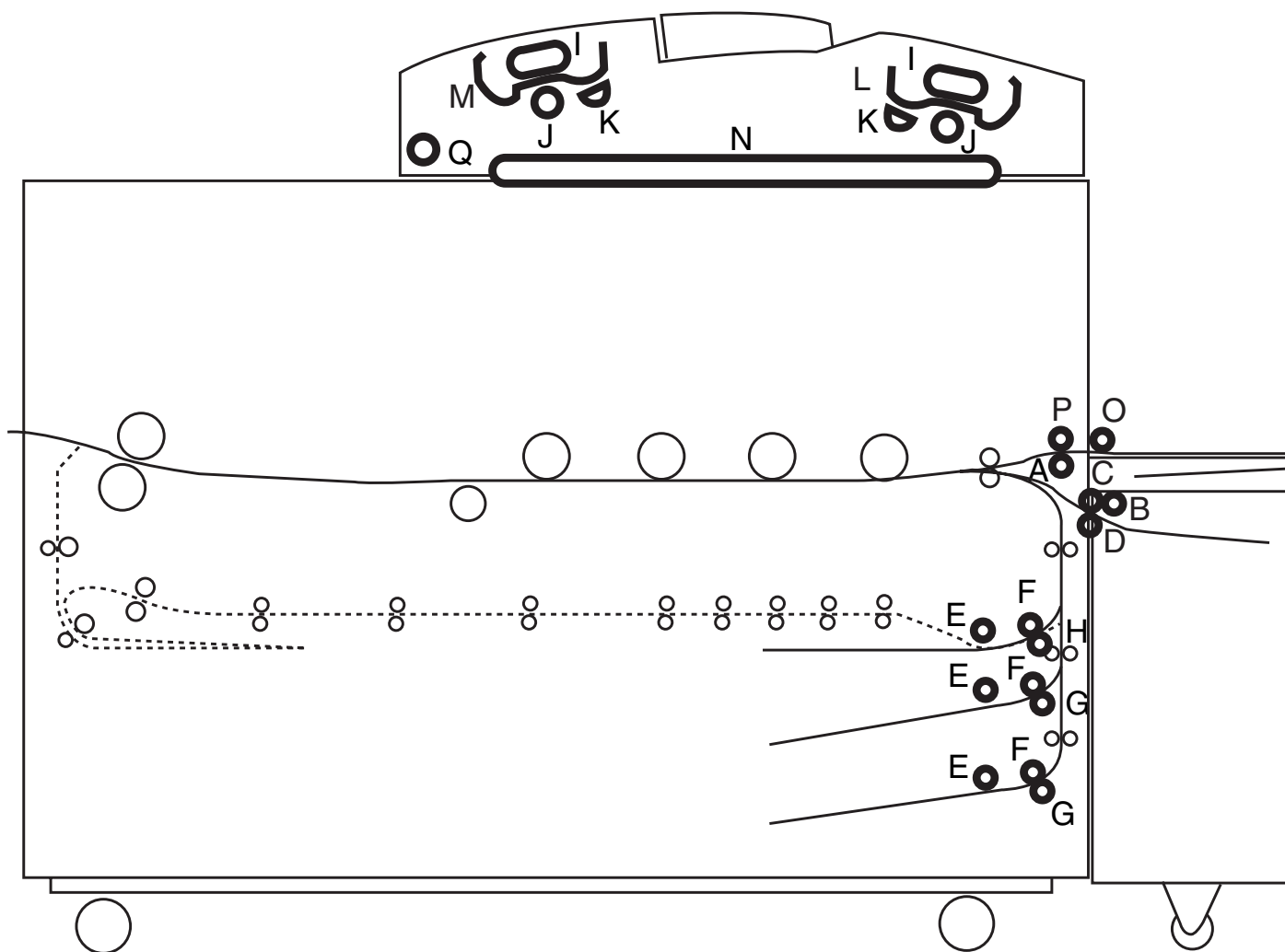

	Description	OEM PN	Katun PN
A	Manual Separation Roller	FF2-4710-000	15636671
A	Manual Separation Roller with hub assembly	FF2-4710-000	15015626
B	Pickup Roller	FF2-5674-020 FF2-5674-000	15011083
C	Feed Roller	FF2-4785-020	15011083
D	Separation Roller	FF2-6312-000	15011084
E	Paper Pickup tire	FF5-2102-000 FF5-2101-000 FB2-0846-000	15020761
F	Feed Roller	FB1-7061-000 FB2-0847-000	15011264
F	Paper Feed Tire	FB2-0847-000 FF5-2103-000	15020762
F	Feed Roller with hub assembly	FB1-7061-000	15016779
G	Separation Roller	FB2-0848-000	15017777
H	Separation Roller	FB1-7060-020	15012801
H	Separation Roller with hub assembly	FB1-7060-020	15016833
I	Separation Belt (RDF-E1)	FA5-5427-000	15015001
J	Feed Roller (RDF-E1)	FC2-1533-000	15013735
K	Pickup Roller (RDF-E1)	FC2-1532-000	15015611
L	Separation Flapper Right (RDF-E1)	FF3-0115-000	15017008
M	Separation Flapper Left (RDF-E1)	FF3-0117-000	15017009
N	Document Feed Belt (RDF-E1)	FC2-1210-000	15014560
O	Paper Pickup Roller	FF5-4327-000	15020905
P	Paper Feed Roller	FF5-4331-000	15020157
Q	Reverse Roller	FF2-1345-000	15021649

## REPLACEMENT KIT

	Description	Katun PN
	<b>250K Maintenance Kit (RDF-E1)</b>	<b>15018277</b>
J	(17) Separation Belts	
K	(22) Feed Rollers	
L	(4) Pickup Rollers	
M	(2) Separation Flappers Right	
N	(3) Separation Flappers Left	
O	(1) Document Feed Belt	

## ADDITIONAL KATUN PARTS

Description	OEM PN	Katun PN
Bearing	XG9-0013-000	15576204
Bearing	XG9-0249-000	15576204
Corona Wire Spring	97-5527-000	15524647
Upper Fuser Roller	FB4-6597-000	15022701
Lower Fuser Roller	FB4-6598-000	15022702

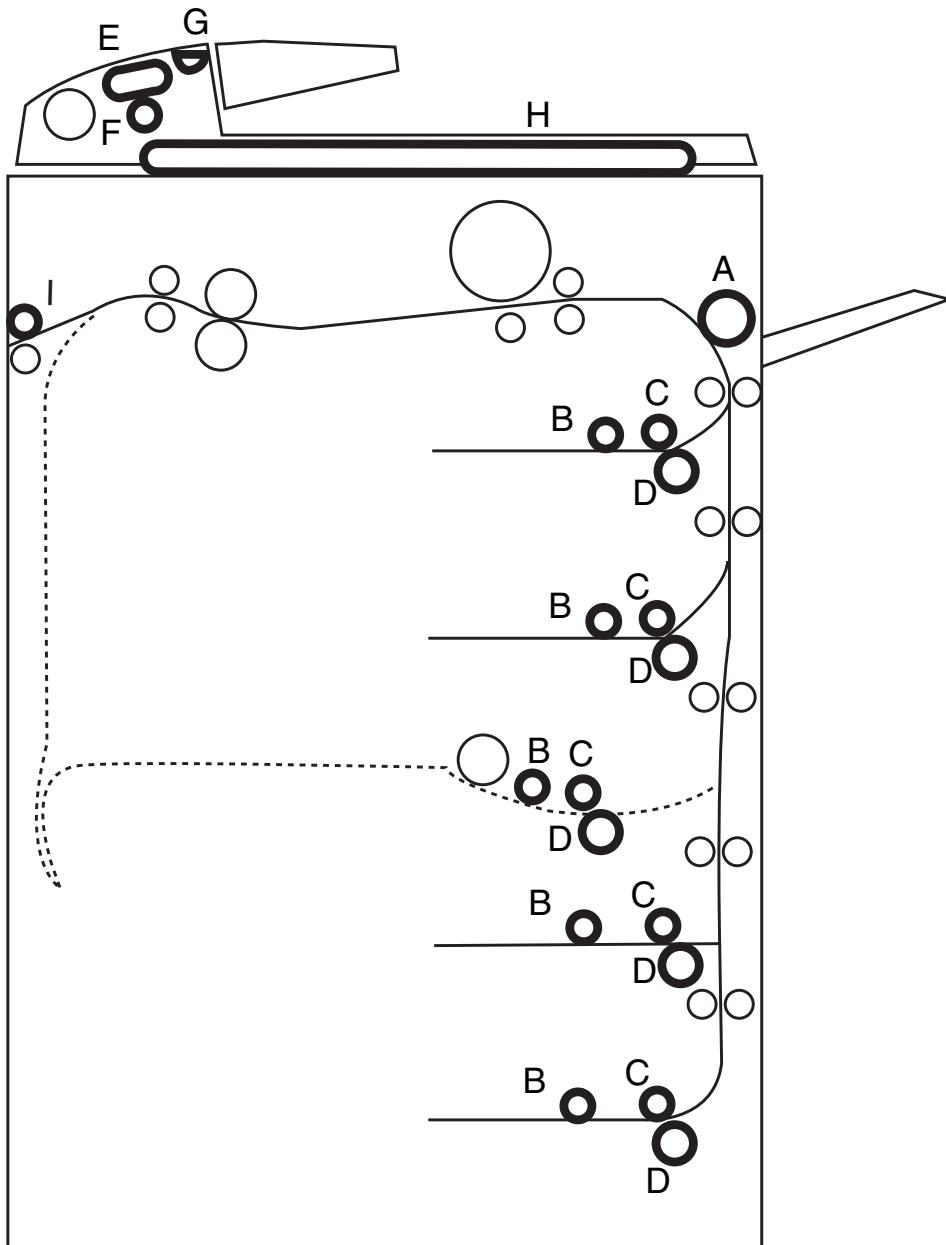



Description	OEM PN	Katun PN
<b>A</b> Manual Pickup Roller	FB1-8581-000	<b>15012302</b>
<b>B</b> Pickup Roller	FF5-1220-000, FF5-1221-000	<b>15017821</b>
<b>C</b> Feed Roller	FB1-7061-000	<b>15011264</b>
<b>C</b> Feed Roller with hub assembly	FB1-7061-000	<b>15016779</b>
<b>D</b> Separation Roller	FB1-7060-000	<b>15012801</b>
<b>D</b> Separation Roller with hub assembly	FB1-7060-000	<b>15016833</b>
<b>E</b> Separation Belt (RDF-C1, ADF-C1)	FA5-5427-000	<b>15015001</b>
<b>F</b> Feed Roller (RDF-C1)	FC1-1259-000	<b>15011369</b>
<b>F</b> Feed Roller (RDF-C1)	FE6-3035-020	<b>15020554</b>
<b>F</b> Feed Roller (RDF-C1)	FE6-3035-000	<b>15014787</b>
<b>F</b> Feed Roller (ADF-C1)	FA5-4654-040	<b>15011368</b>
<b>F</b> Feed Roller (ADF-C1)	FE6-3036-000	<b>15019854</b>
<b>G</b> Pickup Roller (RDF-C1) with hub assembly	FA3-4686-020	<b>15636731</b>
<b>G</b> Pickup Roller (ADF-C1)	FC1-7768-000	<b>15017271</b>
<b>H</b> Original Doc. Feed Belt (RDF-C1, ADF-C1)	FC1-7815-020	<b>15017608</b>
<b>I</b> Exit Tire	FA9-0240-000	<b>15016742</b>

## FEED TIRE KITS

Description	Katun PN
<b>Feed Tire Replacement Kit</b>	<b>15012619</b>
<b>B</b> (4) Pickup Rollers	
<b>C</b> (4) Feed Rollers	
<b>D</b> (4) Separation Rollers	
<b>RDF Rebuild Kit (RDF-C1)</b>	<b>15018575</b>
<b>E</b> (9) Separation Belts	
<b>F</b> (1) Feed Rollers	
<b>G</b> (2) Pickup Rollers with hub assembly	
<b>-</b> (1) Original Feed Roller Gear	
<b>Document Feeder Replacement Kit (RDF-C1)</b>	<b>15012976</b>
<b>E</b> (9) Separation Belts	
<b>F</b> (12) Original Feed Rollers	
<b>G</b> (2) Original Pickup Rollers with hub assembly	

## ADDITIONAL KATUN PARTS

Description	OEM PN	Katun PN
Upper Heat Insulating Sleeve	FB1-6823-000	<b>15013600</b>
Bearing	XG9-0208-000	<b>15576204</b>
Bearing	XG9-0249-000	<b>15576204</b>
Upper Fuser Roller Bearing	XG9-0266-000	<b>15576216</b>
Web Supply Roller	FY1-1046-000	<b>15636505</b>
Web Supply Roller	FY7-0221-000	<b>15636505</b>
Lower Picker Finger	FA2-9037-000	<b>15242562</b>
Upper Picker Finger	FB1-7075-000	<b>15013099</b>
Corona Wire Spring	97-5527-000	<b>15524647</b>
Corona Wire Spring	FS2-2763-000	<b>15524647</b>

## Canon GP-200/200D/200E/200F/200S/210/215/220/225 and imageRunner 200L/210E/210N/210S

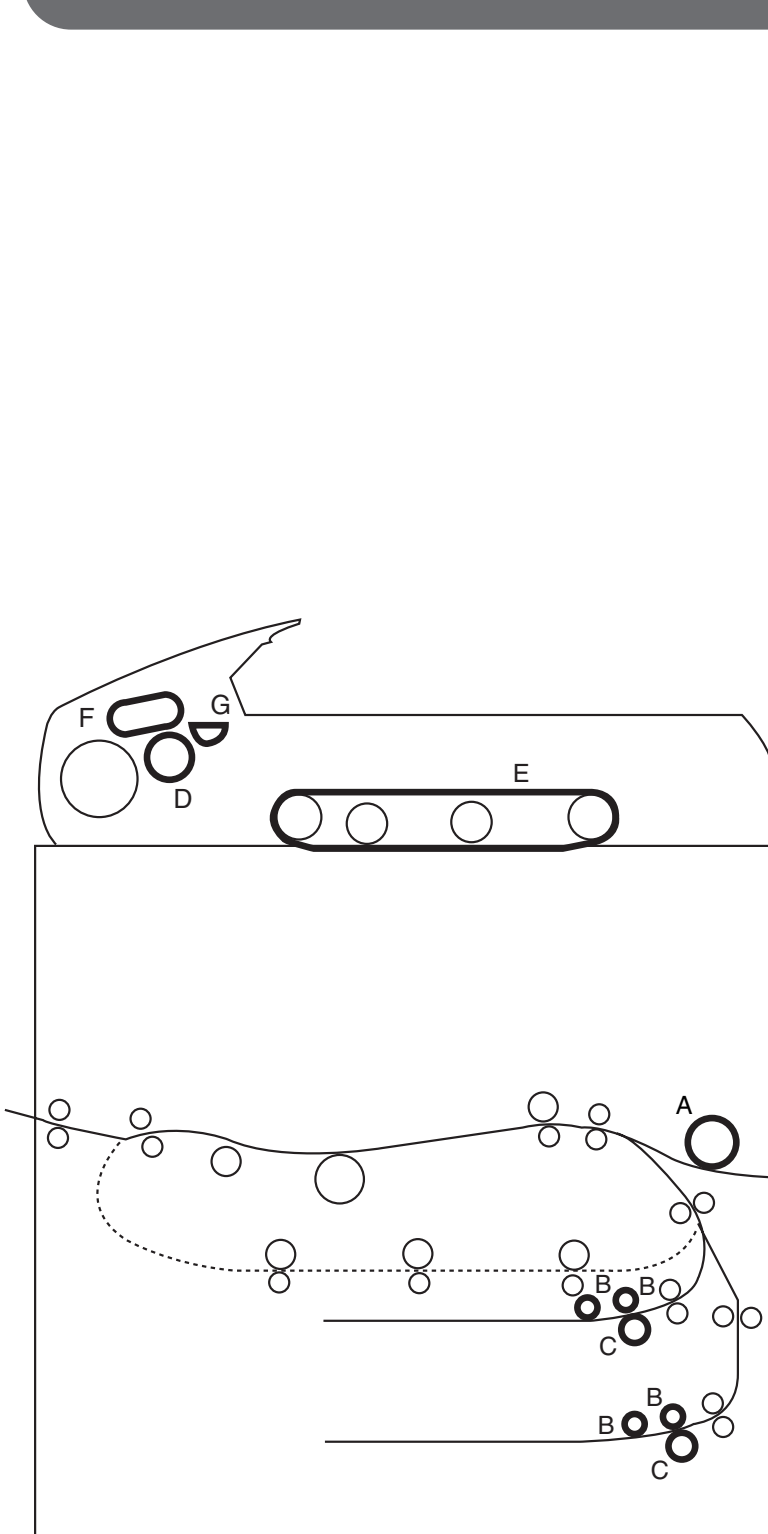

	Description	OEM PN	Katun PN
A	Manual Pickup Roller	FB2-8581-000	15012302
B	Pickup/Feed Roller	FF5-4552-020	15017942
B	Pickup/Feed Roller with hub assembly	FF5-4552-020	15023389
C	Separation Roller	FF5-4634-020	15017941
C	Separation Roller with hub assembly	FF5-4634-020	15022735
D	Feed Roller (RDF-GI)	FC2-1533-000	15013735
E	Original Document Feed Belt (RDF-GI)	FC1-7815-020	15010209 15017608
F	Paper Feed Belt (RDF-GI)	FE6-3059-000 FE6-3059-000 (OEM Style)	15015001 15023494
F	Seperation Belt (RDF-GI)	FB3-5702-000	15019841
G	Original Pickup Roller	FF5-5191-000	15025885

### REPLACEMENT KITS

	Description	Katun PN
	<b>Feed Tire Replacement Kit</b>	15021849
B	(4) Pickup/Feed Rollers	
C	(2) Seperation Rollers	
	<b>Feed Roller Replacement Kit</b>	15026947
B	(4) Pickup/Feed Rollers with hub assembly	
C	(2) Seperation Rollers with hub assembly	

## Canon imageRUNNER 330E/330S/400/400E/400S

Description	OEM PN	Katun PN
-------------	--------	----------

<b>A</b>	Manual Feed Roller	FB1-8581-000	<b>15012302</b>
<b>B</b>	Pickup/Feed Roller	FF5-4552-020	<b>15017942</b>
<b>B</b>	Pickup/Feed Roller with hub assembly	FF5-4552-020	<b>15023389</b>
<b>C</b>	Separation Roller	FF5-4634-020	<b>15017941</b>
<b>C</b>	Separation Roller with hub assembly	FF5-4634-020	<b>15023735</b>
<b>D</b>	Feed Roller (PD-B1)	FB4-2034-000	<b>15018877</b>
<b>E</b>	Pickup Roller	FB4-2033-000	<b>15017821</b>
<b>F</b>	Separation Roller with hub assembly	FB2-7777-000	<b>15021619</b>
<b>G</b>	Feed Roller (DADF-A1)	FB4-6991-000	<b>15013735</b>
<b>H</b>	Original Document Feed Belt (DADF-A1)	FC1-7815-020	<b>15010209</b>

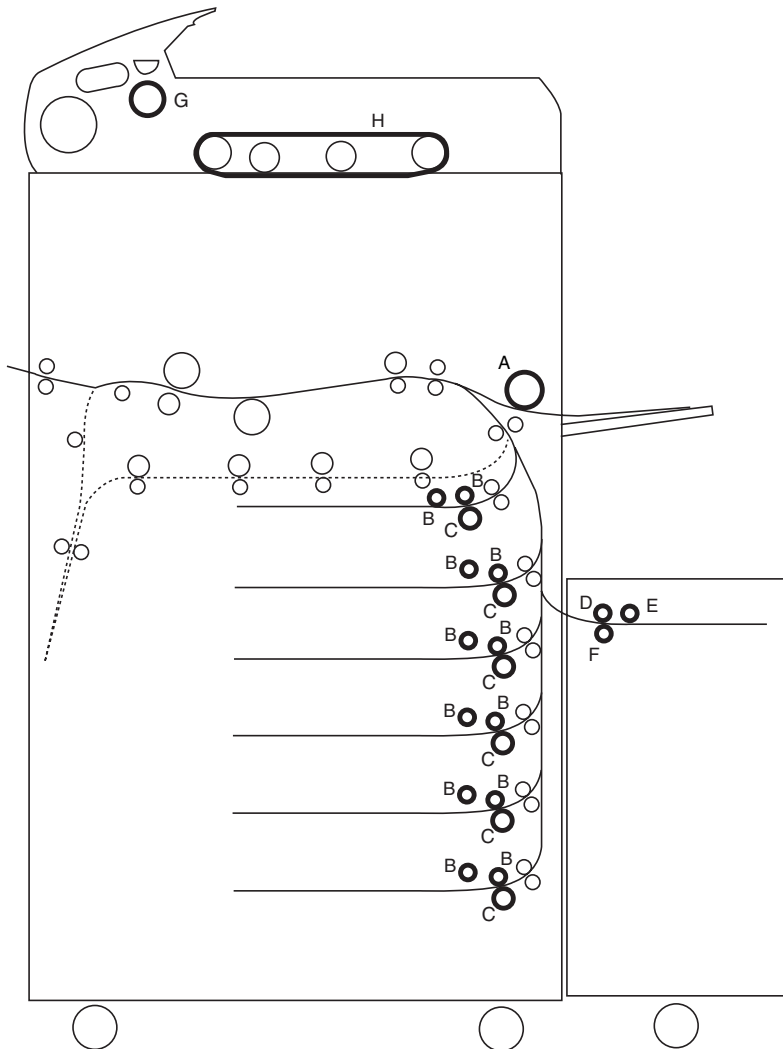

### ADDITIONAL KATUN PARTS

Description	OEM PN	Katun PN
-------------	--------	----------

Upper Heat Insulating Sleeve	FB1-6823-000	<b>15013600</b>
Bearing	XG9-0208-000	<b>15576204</b>
Web Supply Roller	FY1-1046-000	<b>15636505</b>
Lower Picker Finger	FA2-9037-000	<b>15242562</b>
Upper Picker Finger	FB1-7075-000	<b>15013099</b>

### REPLACEMENT KITS

Description	Katun PN
-------------	----------

<b>Feed Tire Replacement Kit</b>	<b>15021849</b>
<b>B</b> (4) Pickup/Feed Rollers	
<b>C</b> (2) Separation Rollers	
<b>Feed Roller Replacement Kit</b>	<b>15026947</b>
<b>B</b> (4) Pickup/Feed Rollers with hub assembly	
<b>C</b> (2) Separation Rollers with hub assembly	
<b>Feed Tire Replacement Kit (PD-B1)</b>	<b>15021762</b>
<b>D</b> (1) Feed Roller	
<b>E</b> (1) Pickup Roller	
<b>F</b> (1) Separation Roller with hub assembly	

## Canon imageRUNNER 550/600

### Description OEM PN Katun PN

<b>A</b>	Manual Pickup Roller	FB4-2033-000	<b>15017821</b>
<b>B</b>	Manual Feed Roller	FB4-2035-000	<b>15017776</b>
<b>C</b>	Sponge Roller with hub assembly	FB2-7545-000	<b>15021650</b>
<b>D</b>	Pickup Roller	FB4-2033-000	<b>15017821</b>
<b>E</b>	Pickup Roller	FF5-7829-000 FF5-7830-000	<b>15017821</b>
<b>F</b>	Paper Pickup/Feed Roller	FB4-2034-000	<b>15018877</b>
<b>G</b>	Seperation Roller with hub assembly	FB2-7777-020	<b>15021619</b>
<b>H</b>	Original Feed Roller	FB4-6991-000	<b>15013735</b>
<b>H</b>	ADF Feed Roller Assembly	FG6-2748-000	<b>15020554</b>
<b>I</b>	Original Document Feed Belt (ADF)	FC2-1210-000	<b>15014560</b>
<b>I</b>	Original Document Feed Belt (ADF)	FB5-9541-000	<b>15018512</b>
<b>J</b>	Paper Feed Belt Paper Feed Belt (OEM Style)	FE6-3059-000 FE6-3059-000	<b>15015001</b> <b>15023494</b>
<b>K</b>	ADF Pickup Roller	FB4-7640-000	<b>15022683</b>
<b>K</b>	ADF Pickup Roller with hub assembly	FB4-7640-000	<b>15021206</b>

### ADDITIONAL KATUN PARTS

#### Description OEM PN Katun PN

Heat Insulating Sleeve	FB2-7239-000	<b>15013600</b>
Bearing	XG9-0208-000	<b>15576204</b>
Bearing	XG9-0249-000	<b>15576204</b>
Lower Picker Finger	FA2-9037-000	<b>15242562</b>
Upper Picker Finger	FC1-0391-040	<b>15016086</b>
Upper Fuser Roller	FB2-7200-000	<b>15014109</b>
Corona Wire Spring	97-5527-000	<b>15524647</b>

### REPLACEMENT KIT

#### Description Katun PN

**Feed Tire Replacement Kit** **15021762**

- E** (2) Pickup Rollers
- F** (2) Paper Pickup/Feed Rollers
- G** (1) Seperation Rollers with hub assembly

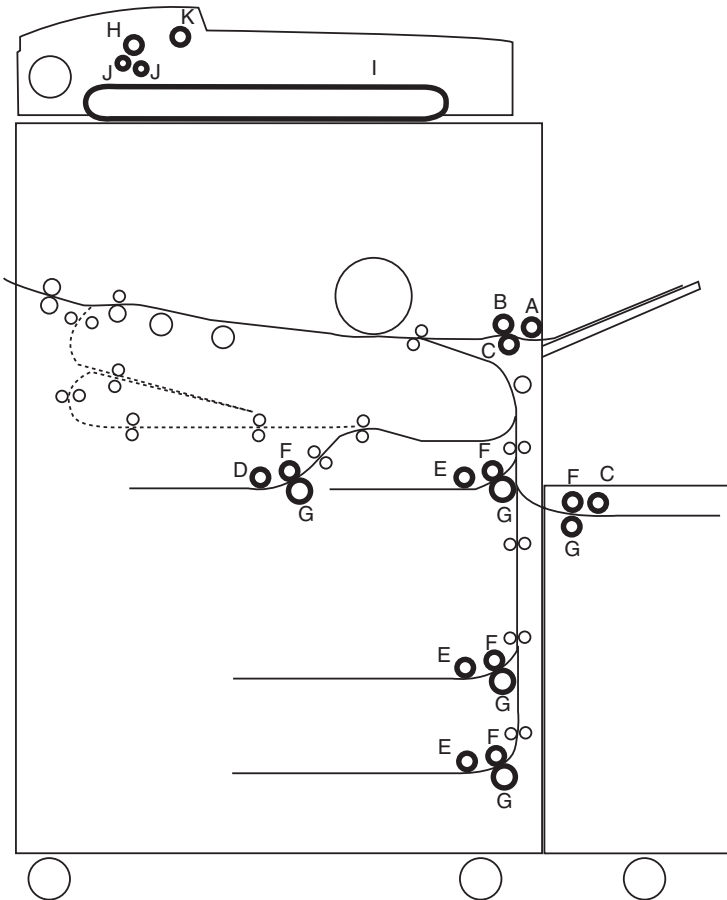

## Canon NP-3525, 3725

	Description	OEM PN	Katun PN
A	Pickup Roller	FF9-0581-030	15000893
B	Feed Roller	FA3-8733-040	15636671
B	Feed Roller with hub assembly	FA3-8733-040	15015626
C	Separation Roller	FA3-8733-040	15636671
C	Separation Roller with hub assembly	FA3-8733-040	15015626
D	Exit Tire	FA9-0240-000	15016742

### ADDITIONAL KATUN PARTS

Description	OEM PN	Katun PN
Bearing	XG9-0013-000	15576204
Upper Fuser Roller Bearing	XG9-0139-000	15576216
Web Supply Roller	FY1-1046-000	15636505
Web Supply Roller	FY7-0221-000	15636505

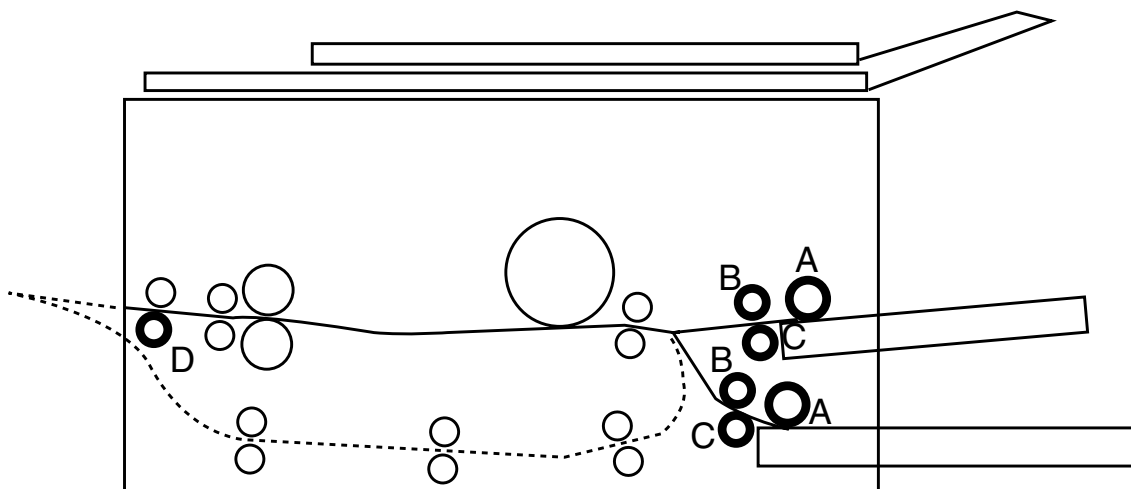

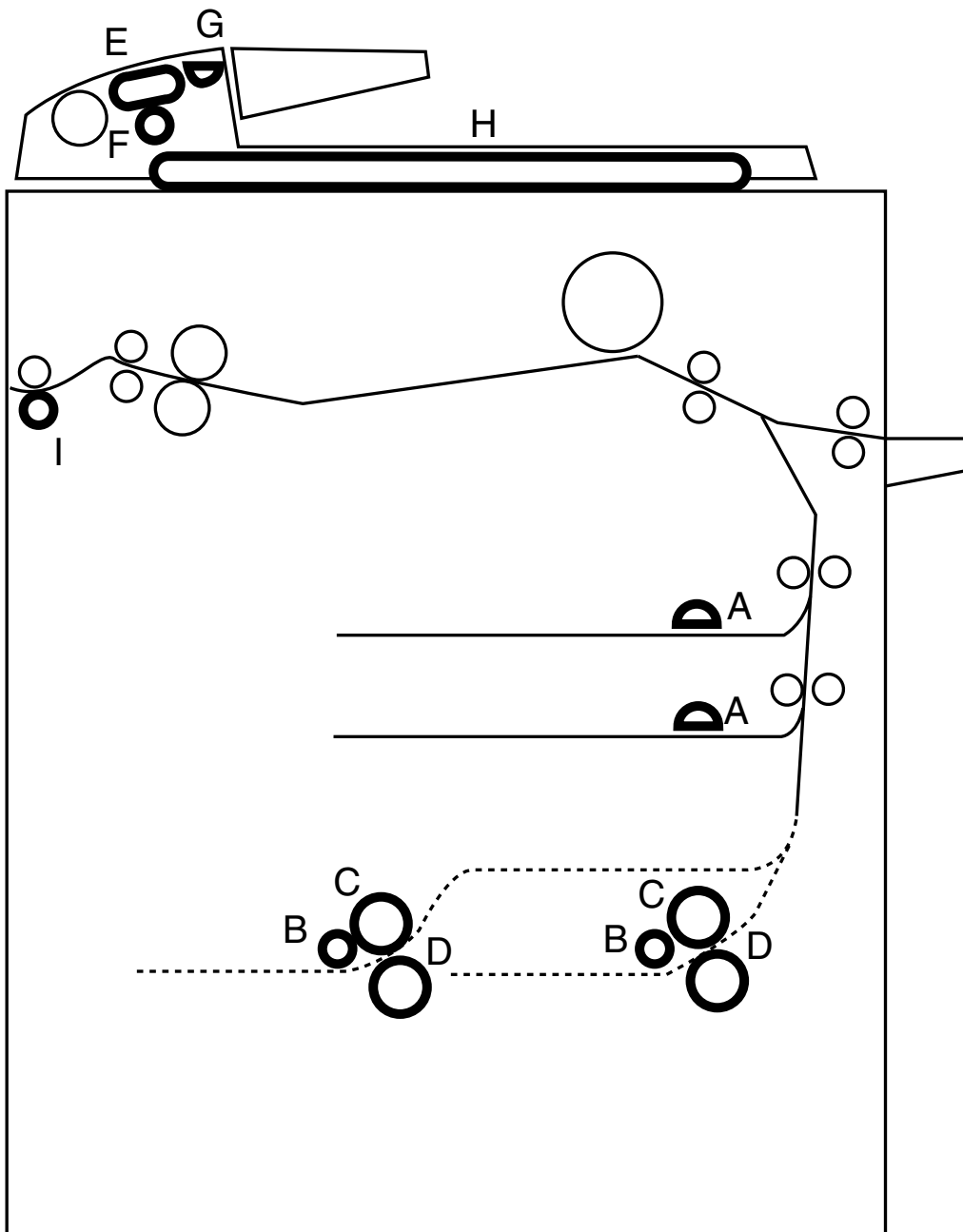

	Description	OEM PN	Katun PN
A	Pickup Roller (CFU-E1)	FA6-5547-000	15012718
B	Pickup Roller (PD-D1/E1)	FA5-2854-030 FF9-1113-030	15000888
C	Feed Roller (PD-D1/E1)	FL9-0009-030	15000886
D	Separation Roller (PD-D1/E1)	FL9-0010-020	15000880
E	Separation Belt (ADF-A1, RDF-B1)	FA5-5427-000	15015001
F	Feed Roller (ADF-A1) (Crepe tire)	FA5-4654-040	15011368
F	Feed Roller (ADF-A1) (Ribbed tire)	FF6-3036-000	15019854
F	Feed Roller (RDF-B1)	FC1-1259-000	15011369
F	Feed Roller (RDF-B1) with shaft assembly	FE6-3035-000	15014787
G	Pickup Roller (ADF-A1, RDF-B1) with hub assembly	FA3-4686-020	15636731
H	Document Feed Belt (RDF-B1)	FC1-7815-020	15010209
I	Exit Tire	FA9-0240-000	15016742

## REPLACEMENT KITS

	Description	Katun PN
	<b>Paper Feed Roller Kit (PD-D1, E1)</b>	<b>15012313</b>
B	(2) Pickup Rollers	
C	(2) Feed Rollers	
D	(2) Separation Rollers	
	<b>Document Feeder Kit (RDF-B1)</b>	<b>15012976</b>
E	(9) Separation Belts	
F	(12) Feed Rollers	
G	(2) Pickup Rollers with hub assembly	
	<b>Document Feeder Kit (ADF-A1)</b>	<b>15014798</b>
E	(6) Separation Belts	
F	(9) Feed Rollers (Ribbed tire)	
G	(2) Pickup Rollers with hub assembly	

## ADDITIONAL KATUN PARTS

Description	OEM PN	Katun PN
Heat Insulating Sleeve	FB1-5928-000	15013942
Bearing	XG9-0013-000	15576204
Drum Cleaning Blade	FA5-2524-000	15243418
Web Supply Roller	FY1-1046-000	15636505
Web Supply Roller	FY7-0221-000	15636505
OPC Drum Kit	N/P/N	15009307
Upper Fuser Roller Bearing Kit	N/P/N	15015697
Lower Picker Finger	FA2-9037-000	15242562
Corona Wire Spring	97-5527-000	15524647

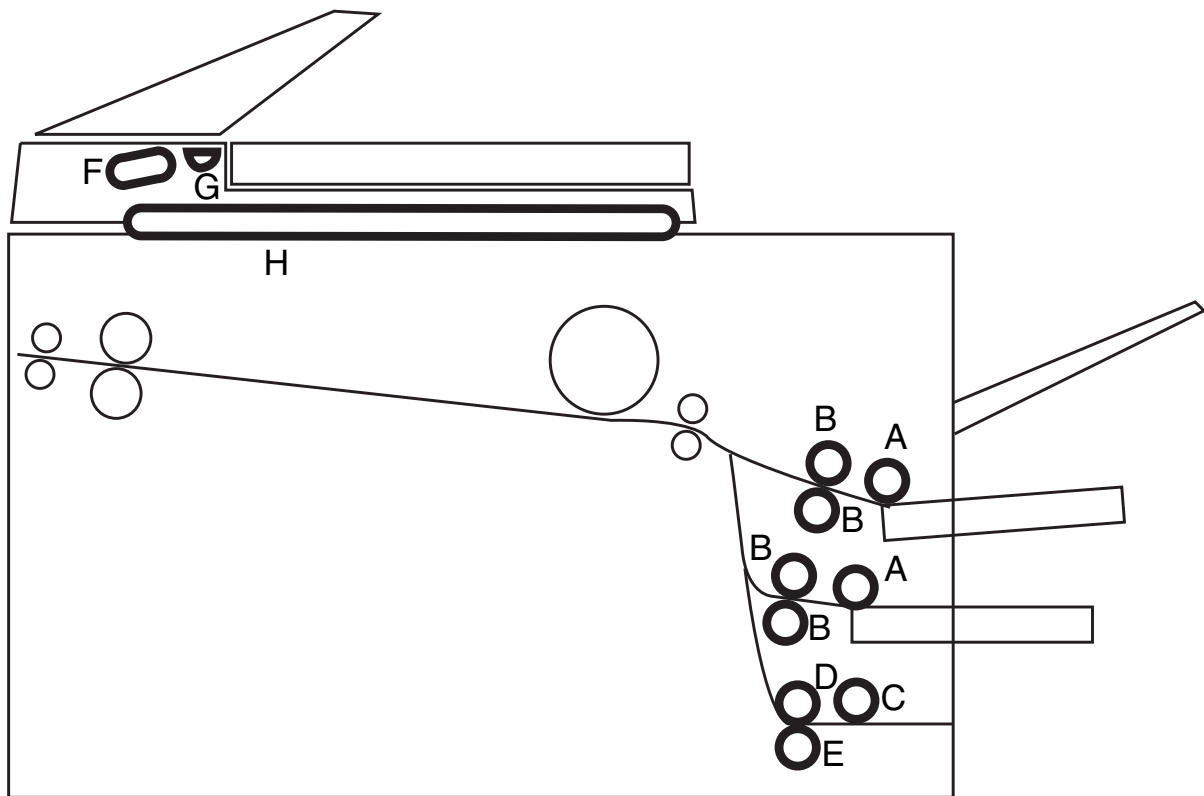



	Description	OEM PN	Katun PN
A	Pickup Roller	FF9-0581-030	15000893
B	Feed Roller/ Separation Roller	FA3-8733-040	15636671
B	Feed Roller/ Separation Roller with hub assembly	FA3-8733-040	15015626
C	Paper Pickup Tire (PD-5)	FA3-2615-020	15012799
D	Feed Roller (PD-5)	FL9-0009-030	15000886
E	Separation Roller (PD-5)	FA6-1038-020	15000892
F	Separation Belt (RDF-1)	FA3-4598-020 FE6-3059-000 (OEM Style)	15015001 15023494
G	Pickup Roller (RDF-1) with hub assembly	FA3-4686-020	15636731
H	Document Feed Belt (RDF-1) with drive coupler	FA3-4683-070	15018127

## ADDITIONAL KATUN PARTS

Description	OEM PN	Katun PN
Bearing	XG9-0013-000	15576204
Upper Fuser Roller Bearing	XG9-0139-000	15576216
Web Supply Roller	FY7-0085-000	15636505
Lower Picker Finger	FA2-8345-000	15013097
Upper Picker Finger	FC1-0391-030	15016086
Corona Wire Spring	97-5527-000	15524647

## Canon NP-4050, 4080, (with RDF-B1) (with PD-D1)

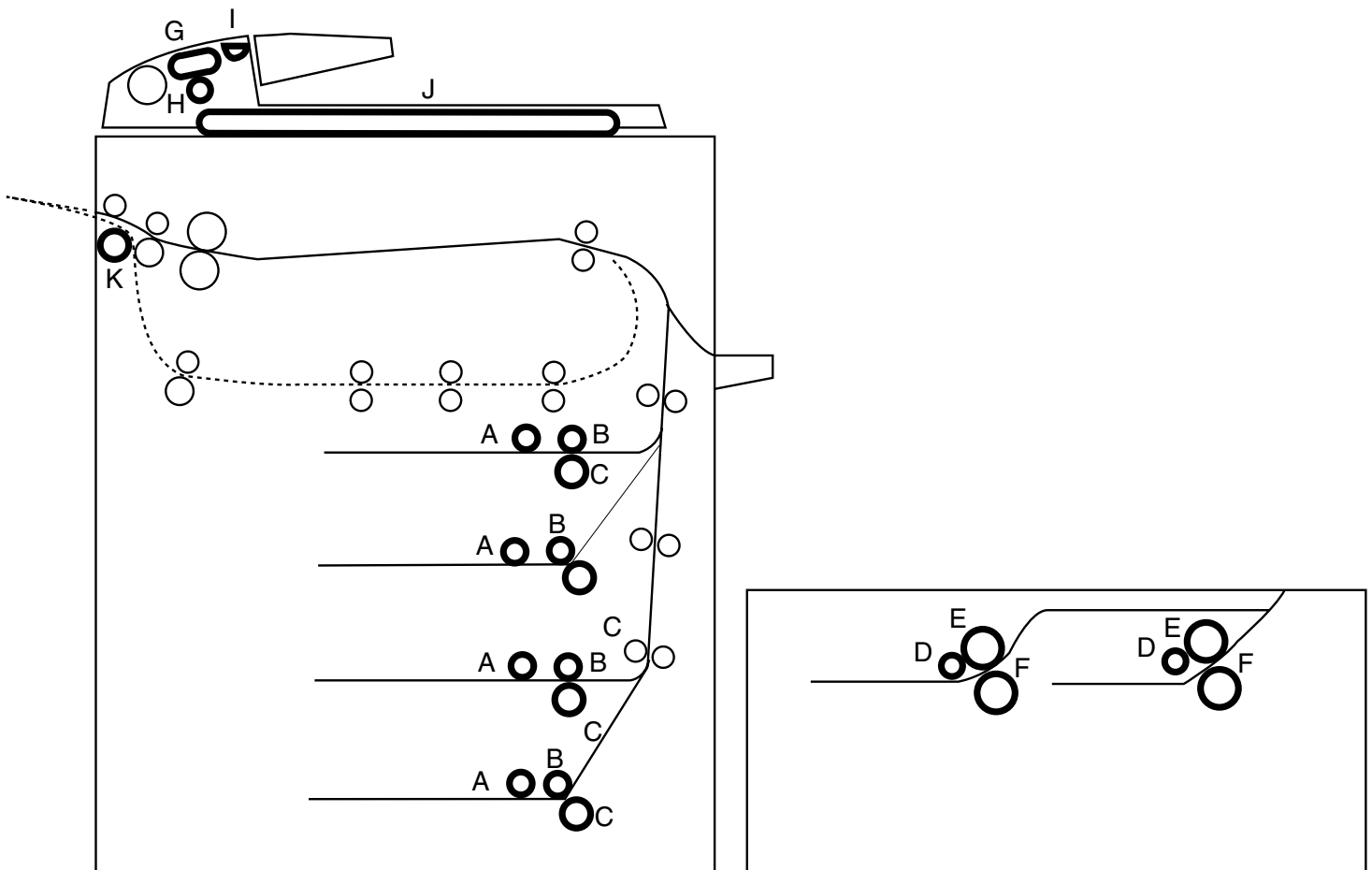

	Description	OEM PN	Katun PN
A	Pickup Roller (CFU-D1)	FF9-1003-050 FA5-2854-030 FF9-1113-030	15000888
B	Feed Roller (CFU-D1)	FA5-2933-020	15012221
B	Feed Roller (CFU-D1) with hub assembly	FA5-2933-020	15015626
C	Separation Roller (CFU-D1)	FA5-2867-020	15012800
D	Pickup Roller (PD-D1)	FA5-2854-030 FF9-1113-030	15000888
D	Pickup Roller (PD-D1)	RF5-1835-000	15022338
E	Feed Roller (PD-D1)	FL9-0009-030	15000886
E	Feed/Separation Roller (PD-D1)	RF5-1834-000	15014243
F	Separation Roller (PD-D1)	FL9-0010-020	15000880
G	Separation Belt (RDF-B1)	FA5-5427-000	15015001
H	Feed Roller (RDF-B1)	FC1-1259-000	15011369
H	Feed Roller (RDF-B1) with shaft assembly	FE6-3035-000	15014787
H	Feed Roller (RDF-B1)	FE6-3035-020	15020554
I	Pickup Roller (RDF-B1) with hub assembly	FA3-4686-020	15636731
J	Document Feed Belt (RDF-B1)	FC1-7815-020	15010209 15017608
K	Exit Tire	FA9-0240-000	15016742

## REPLACEMENT KITS

	Description	Katun PN
	<b>Feed Roller Kit (CFU-D1)</b>	<b>15012618</b>
A	(4) Pickup Rollers	
B	(4) Feed Rollers	
C	(4) Separation Rollers	
	<b>Feed Roller Kit (PD-D1)</b>	<b>15012313</b>
D	(2) Pickup Rollers	
E	(2) Feed Rollers	
F	(2) Separation Rollers	
	<b>Document Feeder Kit (RDF-B1)</b>	<b>15012976</b>
G	(9) Separation Belts	
H	(12) Feed Rollers	
I	(2) Pickup Rollers	

## ADDITIONAL KATUN PARTS

Description	OEM PN	Katun PN
Heat Insulating Sleeve	FB1-5928-000	15013942
Bearing	XG9-0208-000	15576204
Drum Cleaning Blade	FA5-2524-000	15243418
Web Supply Roller	FY1-1046-000	15636505
Web Supply Roller	FY7-0221-000	15636505
Lower Picker Finger	FA2-9037-000	15242562
Upper Picker Finger	FB1-7075-000	15013099
Corona Wire Spring	97-5527-000	15524647



	Description	OEM PN	Katun PN
A	Feed Roller	FA5-2933-020	15012221
A	Feed Roller with hub assembly	FA5-2933-020 FA3-8733-040	15015626
B	Pickup Roller	FF9-1003-050 FF9-1113-030 FA5-2854-030	15000888
C	Separation Roller	FA5-2867-020	15012800
D	Pickup Roller (PD-8)	FF9-1003-050 FF9-1113-030	15000888
E	Feed Roller (PD-8)	FE9-0019-000	15000886
F	Separation Roller (PD-8)	FA5-3466-020	15000880
G	Reverse Roller (RDF-2)	FA5-5392-000	15011334
H	Separation Belt	FA5-5427-000	15015001
I	Original Separation Roller (D-ADF) (Crepe tire)	FA5-4654-040	15011368
I	Original Feed Roller Unit (D-ADF) (Ribbed tire)	FF2-9926-000	15019854
I	Original Feed Roller Unit (RDF-2)	FA5-5416-000	15011368
I	Feed Roller Assembly (RDF-2) with shaft assembly	FF2-9926-000	15014698
J	Pickup Roller (D-ADF) with hub assembly	FA3-4686-020	15636731
J	Pickup Roller (RDF-2) with hub assembly	FA5-5410-000	15011549
K	Document Feed Belt (RDF-2)	FA3-4683-070	15018127
L	Exit Tire	FA9-0240-000	15016742

## REPLACEMENT KITS

	Description	Katun PN
	<b>Feed Roller Kit (CFU-D1)</b>	<b>15012618</b>
A	(4) Feed Rollers	
B	(4) Pickup Rollers	
C	(4) Separation Rollers	
	<b>Feed Roller Kit (PD-8)</b>	<b>15012313</b>
D	2) Pickup Rollers	
E	(2) Feed Rollers	
F	(2) Separation Rollers	
	<b>Document Feeder Kit (RDF-2)</b>	<b>15011753</b>
G	(4) Reverse Rollers	
H	(6) Separation Belts	
I	(9) Feed Rollers	
J	(2) Pickup Rollers with hub assembly	
	<b>Document Feeder Kit (RDF-2)</b>	<b>15012139</b>
H	(6) Separation Belts	
I	(9) Feed Rollers	
J	(2) Pickup Rollers	
	<b>RDF Rebuild Kit (RDF-2)</b>	<b>15017473</b>
H	(6) Separation Belts	
I	(1) Feed Roller with shaft assembly	
J	(2) Pickup Rollers	
-	(1) Gear	

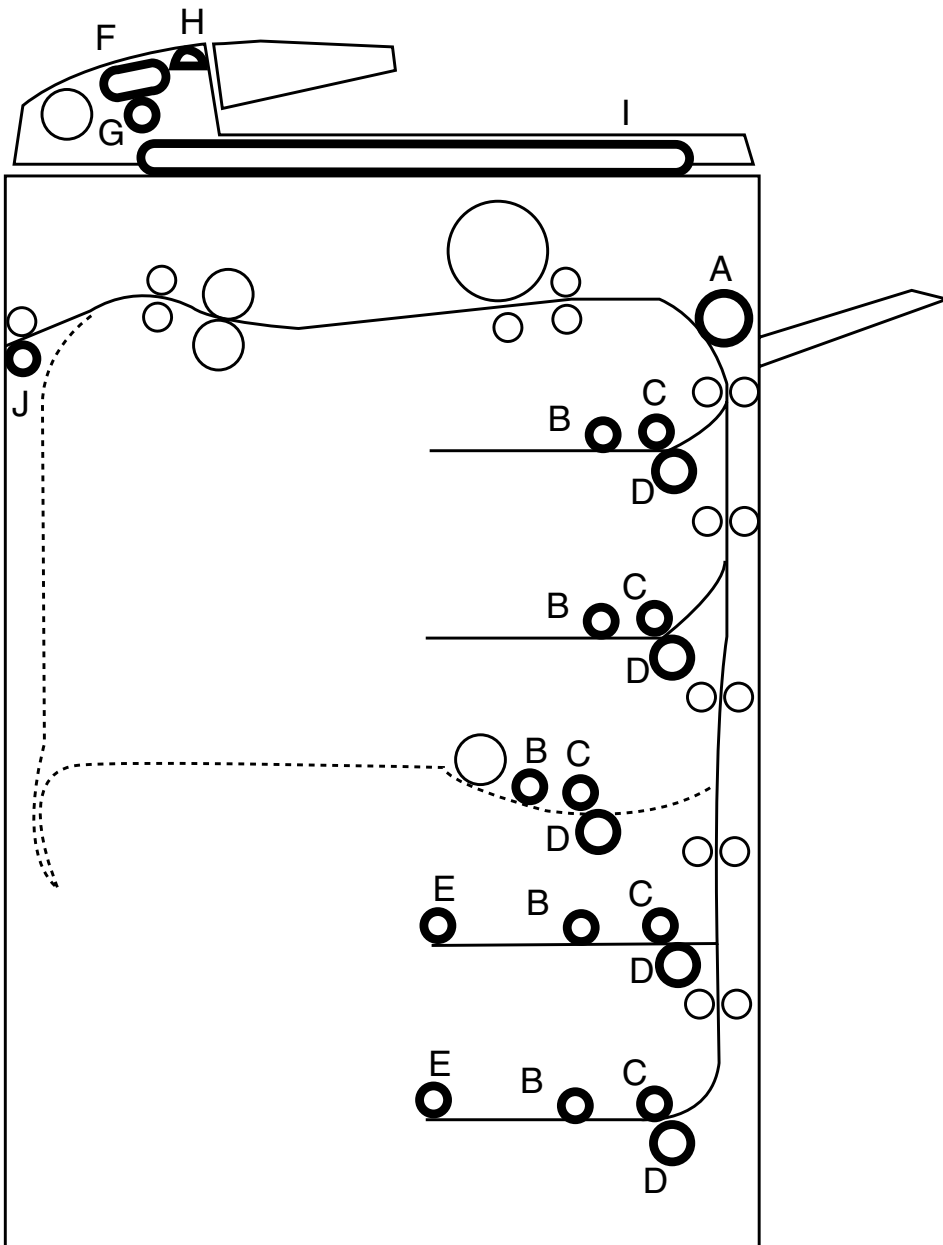

	Description	OEM PN	Katun PN
A	Pickup Roller	FB1-8581-000	15012302
B	Pickup Roller	FF5-1220-000 FF5-1221-000	15017821
C	Feed Roller	FB1-7061-000	15011264
C	Feed Roller with hub assembly	FB1-7061-000	15016779
D	Separation Roller	FB1-7060-020	15012801
D	Separation Roller with hub assembly	FB1-7060-020	15016833
E	Pickup Roller	FB3-6483-000	15016345
F	Separation Belt	FA5-5427-000	15015001
G	Feed Roller (ADF-C1)	FA5-4654-040	15011368
G	Feed Roller (RDF-C1)	FC1-1259-000	15011369
G	Feed Roller (RDF-C1) with shaft assembly	FE6-3035-000	15014787
H	Pickup Roller (RDF-C1) with hub assembly	FA3-4686-020	15636731
I	Document Feed Belt	FC1-7815-020	15010209
J	Exit Tire	FA9-0240-000	15016742

## REPLACEMENT KITS

	Description	Katun PN
	<b>Feed Roller Kit (CFU-D1)</b>	<b>15012619</b>
B	(4) Pickup Rollers	
C	(4) Feed Rollers	
D	(4) Separation Rollers	
	<b>Document Feeder Kit (RDF-C1)</b>	<b>15012976</b>
F	(9) Separation Belts	
G	(12) Feed Rollers	
H	(2) Pickup Rollers hub assembly	

## ADDITIONAL KATUN PARTS

Description	OEM PN	Katun PN
Upper Heat Insulating Sleeve	FB1-6823-000	15013600
Bearing	XG9-0208-000	15576204
Upper Fuser Roller Bearing	XG9-0266-000	15576216
Web Supply Roller	FY1-1046-000	15636505
Web Supply Roller	FY7-0221-000	15636505
Lower Picker Finger	FA2-9037-000	15242562
Upper Picker Finger	FB1-7075-000	15013099

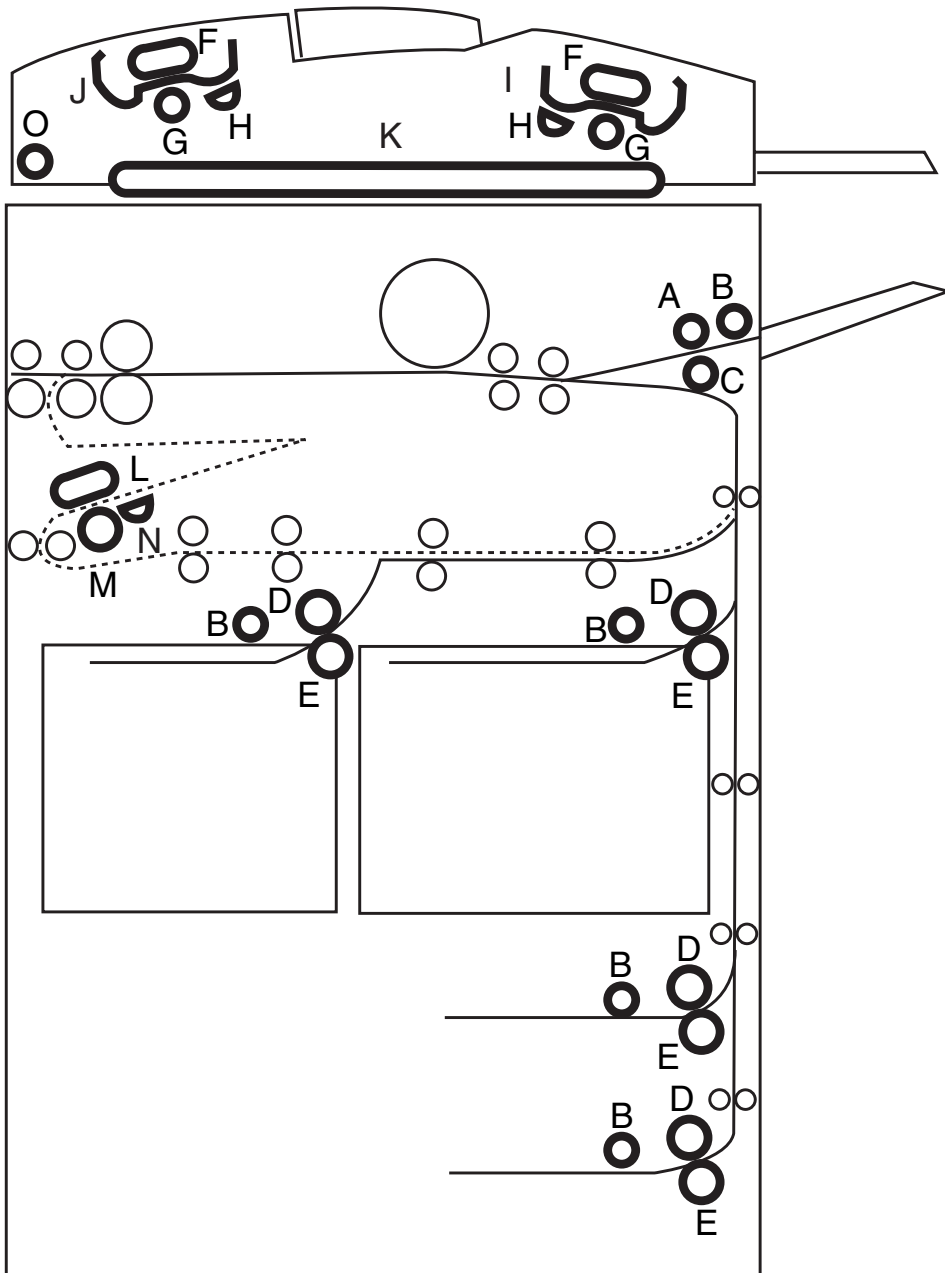



	Description	OEM PN	Katun PN
A	Feed Roller	FB2-7522-000	15014060
B	Pickup Roller	FF5-1220-000 FF5-1221-000	15017821
C	Sponge Roller with hub assembly	FB2-7545-000	15021650
D	Feed Roller	FB2-7695-000	15017777
E	Separation Roller With hub assembly	FB2-7777-020	15021619
F	Separation Belt	FA5-5427-000	15015001
G	Feed Roller (RDF-D1)	FC2-1533-000	15013735
H	Pickup Roller (RDF-D1) with hub assembly	FC2-1532-000	15015611
I	Separation Flapper (RDF-D1) – Right	FF3-0115-000	15017008
J	Separation Flapper (RDF-D1) – Left	FF3-0117-000	15017009
K	Document Feed Belt (RDF-D1)	FC2-1210-000	15014560
L	Duplex Separation Belt	FA5-5427-000	15015001
M	Duplex Feed Roller	FC2-1533-000	15013735
N	Duplex Pickup Roller with hub assembly	FC2-1532-000	15015611
O	Reverse Roller (RDF-D1)	FC2-1345-000	15021649

## REPLACEMENT KIT

Description	Katun PN
<b>250K Maintenance Kit (RDF-D1)</b>	<b>15018277</b>
F (17) Separation Belts	
G (22) Feed Rollers	
H (4) Pickup Rollers	
I (2) Separation Flapper – Right	
J (3) Separation Flapper – Left	
K (1) Document Feed Belt	
<b>Feed Tire Replacement Kit</b>	<b>15021706</b>
B (2) Pickup Rollers	
D (2) Feed Rollers	
E (1) Separation Roller with hub assembly	

## ADDITIONAL KATUN PARTS

Description	OEM PN	Katun PN
Heat Insulating Sleeve	FB2-7239-000	15013600
Bearing	XG9-0208-000	15576204
Separation Belt	FA5-5427-000	15015001
Web Supply Roller	FY1-1046-000	15636505
Web Supply Roller	FY7-0221-000	15636505
Lower Picker Finger	FA2-9037-000	15242562
Upper Picker Finger	FC1-0391-030	15016086
Upper Fuser Roller	FB2-7200-000	15014109
Corona Wire Spring	97-5527-000	15524647

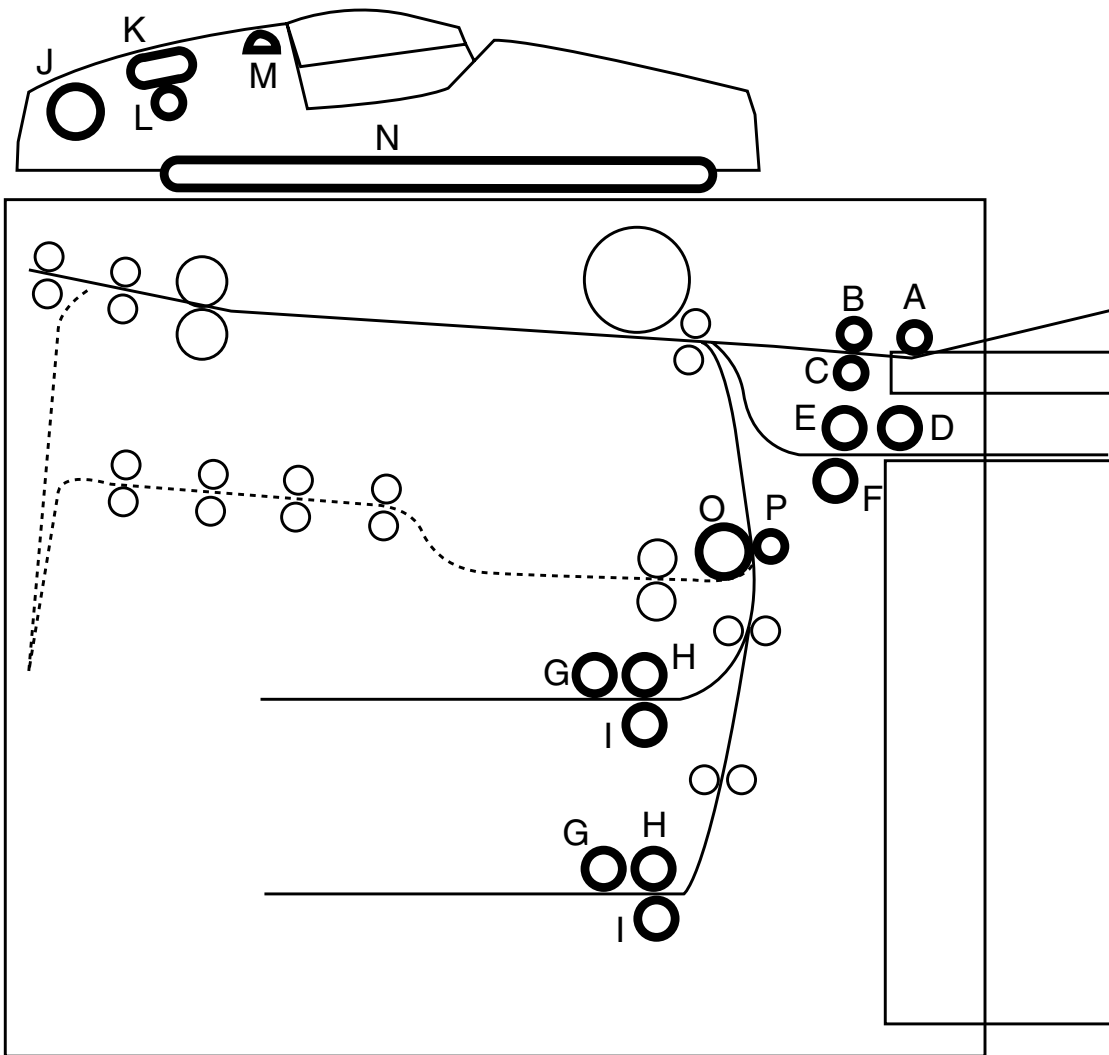

	Description	OEM PN	Katun PN
A	Pickup Roller	FF9-1113-030 FA5-2854-030	15000888
B	Feed Roller	FA6-7727-030	15000887
C	Separation Roller ("old style")	FA3-8733-040 FF2-4710-000	15636671
C	Separation Roller with hub assembly	FA3-8733-040 FF2-4710-000	15015626
C	Separation Roller ("new style")	FA6-7704-000	15012221
D	Pickup Roller	FA6-8089-020	15011083
E	Feed Roller	FC1-5637-000	15012168
F	Separation Roller	FA6-8090-020	15011084
F	Separation Roller with hub assembly	FF3-0067-000	15020114
G	Pickup Roller	FA6-7777-020	15011064
H	Feed Roller	FA6-8089-020	15011083
I	Separation Roller	FC1-9410-000	15011084
I	Separation Roller with hub assembly	FF3-0067-000	15020114
J	Reverse Roller (RDF-A1)	FA5-5392-000	15011334
J	Reverse Roller (RDF-A1) with shaft assembly	FA5-5392-000	15015255
K	Separation Belt (RDF-A1)	FA5-5427-000	15015001
L	Feed Roller (RDF-A1)	FA6-8686-000 FA5-5416-000	15011368
L	Feed Roller (RDF-A1) with shaft assembly	FF2-9926-000	15014698
M	Pickup Roller (RDF-A1) with hub assembly	FA5-5410-000	15011549
N	Document Feed Belt (RDF-A1)	FA3-4683-070	15018127
O	Duplex Separation Roller	FC1-9410-000	15011084
P	Duplex Feed Roller	FA6-8089-020	15011083

## REPLACEMENT KITS

	Description	Katun PN
	<b>Front Tray Feed Roller Kit</b>	<b>15021488</b>
G	(4) Pickup Rollers	
H	(4) Feed Rollers	
I	(2) Separation Rollers with hub assembly	
	<b>Side Tray Feed Roller Kit</b>	<b>15021489</b>
D	(2) Pickup Rollers	
E	(2) Feed Rollers	
F	(1) Separation Roller with hub assembly	
	<b>Document Feeder Kit (RDF-2)</b>	<b>15011753</b>
J	(4) Reverse Rollers	
K	(6) Separation Belts	
L	(9) Feed Rollers	
M	(2) Pickup Rollers with hub assembly	
	<b>Document Feeder Kit (RDF-2)</b>	<b>15012139</b>
K	(6) Separation Belts	
L	(9) Feed Rollers	
M	(2) Pickup Rollers with hub assembly	
	<b>RDF Rebuild Kit (RDF-A1)</b>	<b>15017473</b>
K	(6) Separation Belts	
L	(1) Feed Roller with shaft assembly	
M	(2) Pickup Rollers with hub assembly	
-	(1) Gear	

## ADDITIONAL KATUN PARTS

Description	OEM PN	Katun PN
Bearing	XG9-0208-000	15576204
Upper Fuser Roller Bearing	XG9-0247-000	15576216
Bearing	XG9-0249-000	15576204
Web Supply Roller	FA5-3720-000	15632388
Web Supply Roller	FY1-1045-000	15632388
Lower Picker Finger	FA2-8345-000	15013097
Upper Picker Finger	FC1-0391-030	15016086
Corona Wire Spring	97-5527-000	15524647

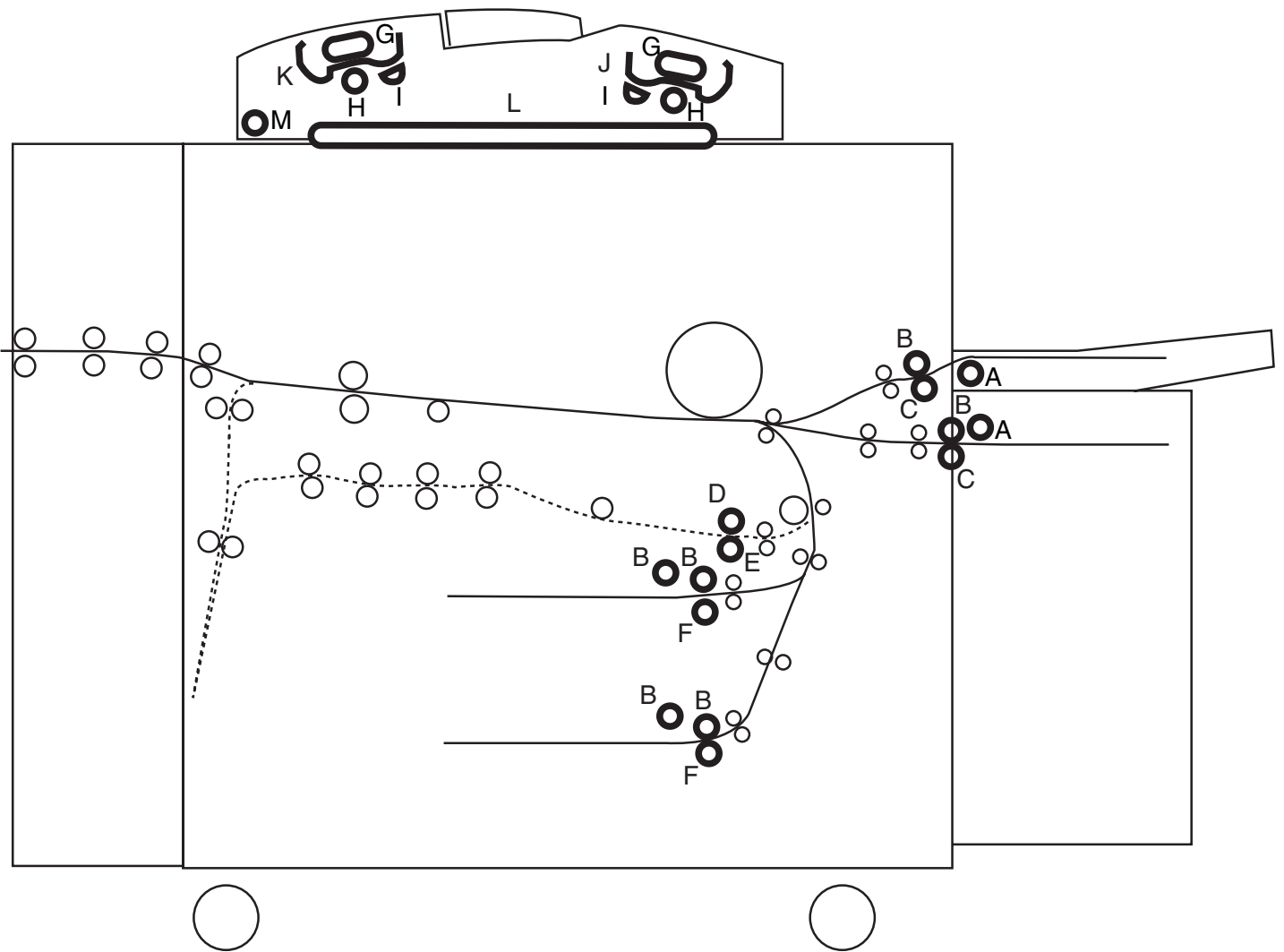

	Description	OEM PN	Katun PN
A	Pickup Roller	FA6-7777-020	15011064
B	Feed Roller	FA6-8089-020	15011083
C	Separation Roller with hub assembly	FB2-9296-000	15022033
D	Duplex Separation Roller (220V)	FB3-9699-000	15017022
D	Duplex Separation Roller (100V)	FF2-6312-000	15011084
E	Rubber Roller (Holding Tray Assembly)	FA6-8089-000 FA6-8089-020	15011083
F	Separation Roller with hub assembly	FB2-7777-020	15021619
G	Separation Belt (RDF-D1)	FA5-5427-000	15015001
H	Feed Roller (RDF-D1)	FC2-1533-000	15013735
I	Pickup Roller (RDF-D1)	FC2-1532-000	15015611
J	Separation Flapper Right (RDF-D1)	FF3-0115-000	15017008
K	Separation Flapper Left (RDF-D1)	FF3-0117-000	15017009
L	Document Felt Belt (RDF-D1)	FC2-1210-000	15014560
M	Reverse Roller	FC2-1345-000	15021649

## REPLACEMENT KIT

	Description	Katun PN
	<b>250K Maintenance Kit (RDF-D1)</b>	<b>15018277</b>
F	(17) Separation Belts	
G	(22) Feed Rollers	
H	(4) Pickup Rollers	
I	(2) Separation Flappers Right	
J	(3) Separation Flappers Left	
K	(1) Document Feed Belt	

## ADDITIONAL KATUN PARTS

Description	OEM PN	Katun PN
Bearing	XG9-0013-000	15576204
Bearing	XG9-0208-000	15576204
Upper Fuser Roller Bearing	XG9-0247-000	15576216
Bearing	XG9-0249-000	15576204
Web Supply Roller	FA5-3720-000	15632388
Web Supply Roller	FY1-1045-000	15632388
Lower Picker Finger	FA2-8345-000	15013097
Upper Picker Finger	FC1-0391-030	15016086
Corona Wire Spring	97-5527-000	15524647

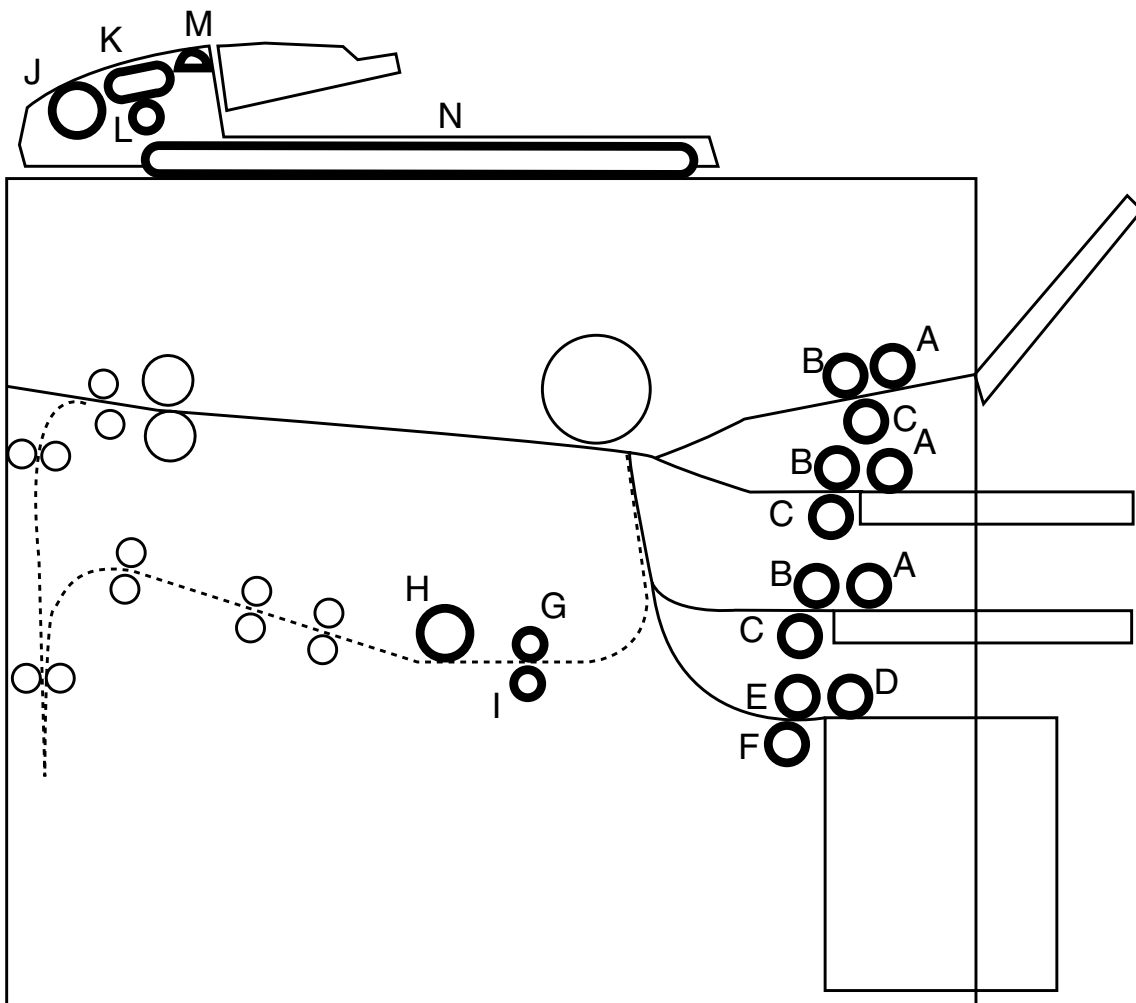

	Description	OEM PN	Katun PN
A	Pickup Roller	FF9-0581-030	15000893
B	Feed Roller	FA3-8733-040	15636671
B	Feed Roller with hub assembly	FA3-8733-040	15015626
C	Separation Roller	FF2-4710-000	15636671
C	Separation Roller with hub assembly	FF2-4710-000	15015626
D	Pickup Roller	FA5-7789-000	15012798
E	Feed Roller	FL9-0009-030	15000886
F	Separation Roller	FA6-1038-020	15000892
G	Duplex Pickup Roller	FC2-3309-000 FA5-3449-020	15000881
H	Duplex Feed Roller	FA5-4534-020	15000884
I	Duplex Separation Roller	FF3-1439-000	15000894
J	Reverse Roller (RDF-2)	FA5-5392-000	15011334
K	Separation Belt (D-ADF, RDF-2)	FA5-5427-000	15015001
L	Feed Roller (D-ADF)	FA5-4654-040	15011368
L	Feed Roller (RDF-2)	FA5-5416-000	15011368
L	Feed Roller (RDF-2) with shaft assembly	FF2-9926-000	15014698
M	Pickup Roller (D-ADF) with hub assembly	FA3-4686-020	15636731
M	Pickup Roller (RDF-2) with hub assembly	FA5-5410-000	15011549
M	Pickup Roller (D-ADF, RDF-2) with hub assembly	FC2-1084-000	15015551
N	Document Feed Belt (D-ADF, RDF-2) with drive coupler	FA3-4683-070	15018127

## REPLACEMENT KITS

	Description	Katun PN
	<b>Feed Roller Kit (Paper Deck)</b>	<b>15012653</b>
D	(2) Pickup Rollers	
E	(2) Feed Rollers	
F	(2) Separation Rollers	
	<b>Document Feeder Kit (RDF-2)</b>	<b>15011753</b>
J	(4) Reverse Rollers	
K	(6) Separation Belts	
L	(9) Feed Rollers	
M	(2) Pickup Rollers with hub assembly	
	<b>Document Feeder Kit (RDF-2)</b>	<b>15012139</b>
K	(6) Separation Belts	
L	(9) Feed Rollers	
M	(2) Pickup Rollers with hub assembly	

## ADDITIONAL KATUN PARTS

Description	OEM PN	Katun PN
Lower Fuser Roller Bearing	XG9-0018-000	15021524
Upper Fuser Roller Bearing	XG9-0139-000	15576216
Web Supply Roller	FA5-3720-000	15632388
Web Supply Roller	FY1-1045-000	15632388
Lower Picker Finger	FA2-8345-000	15013097
Upper Picker Finger	FC1-0391-030	15016086
Corona Wire Spring	97-5527-000	15524647

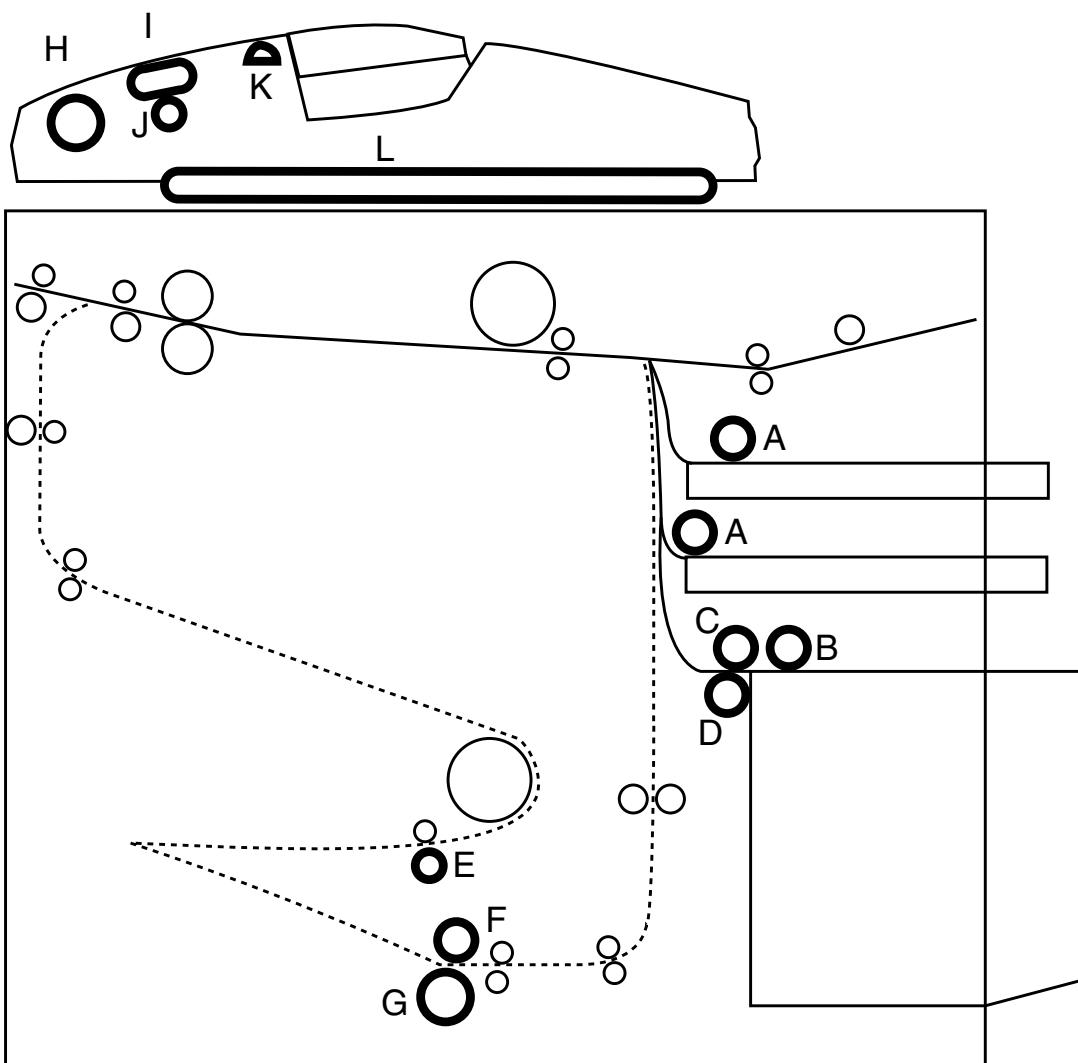



Description	OEM PN	Katun PN
<b>A</b> Pickup Roller	FA3-2615-020	<b>15012799</b>
<b>B</b> Pickup Roller	FA5-7789-000	<b>15012798</b>
<b>C</b> Feed Roller	FL9-0077-020	<b>15000896</b>
<b>D</b> Separation Roller	FL9-0078-030	<b>15000897</b>
<b>E</b> Duplex Pickup Roller	FA3-2615-020	<b>15012799</b>
<b>F</b> Duplex Feed Roller	FL9-0009-030	<b>15000886</b>
<b>G</b> Duplex Separation Roller	FL9-0070-020	<b>15000895</b>
<b>H</b> Reverse Roller (RDF-A1)	FA5-5392-000	<b>15011334</b>
<b>H</b> Reverse Roller (RDF-A1) with shaft assembly	FA5-5392-000	<b>15015255</b>
<b>I</b> Separation Belt (RDF-A1)	FA5-5427-000	<b>15015001</b>
<b>J</b> Feed Roller (RDF-A1)	FA6-8686-000 FA5-5416-000	<b>15011368</b>
<b>J</b> Original Feed Roller (RDF-A1) Ribbed tire	FF2-9926-000	<b>15019854</b>
<b>J</b> Feed Roller (RDF-A1) with shaft assembly	FF2-9926-000	<b>15014698</b>
<b>K</b> Pickup Roller (RDF-A1) with hub assembly	FA5-5410-000	<b>15011549</b>
<b>L</b> Document Feed Belt (RDF-A1)	FA3-4683-070 FY1-0940-000	<b>15018217</b>
<b>L</b> Document Feed Belt (RDF-A1) with drive coupler	FA3-4683-070 FY1-0940-000	<b>15018127</b>

## REPLACEMENT KITS

Description	Katun PN
<b>Document Feeder Kit (RDF-A1)</b>	<b>15011753</b>
<b>H</b> (4) Reverse Rollers	
<b>I</b> (6) Separation Belts	
<b>J</b> (9) Feed Rollers	
<b>K</b> (2) Pickup Rollers with hub assembly	
<b>Document Feeder Kit (RDF-A1)</b>	<b>15012139</b>
<b>I</b> (6) Separation Belts	
<b>J</b> (9) Feed Rollers	
<b>K</b> (2) Pickup Rollers with hub assembly	

## ADDITIONAL KATUN PARTS

Description	OEM PN	Katun PN
Upper Fuser Roller Bearing	FS1-1334-020	<b>15576217</b>
Bearing	XG9-0013-000	<b>15576204</b>
Web Supply Roller	FA5-3720-000	<b>15632388</b>
Web Supply Roller	FY1-1045-000	<b>15632388</b>
Corona Wire Spring	97-5527-000	<b>15524647</b>

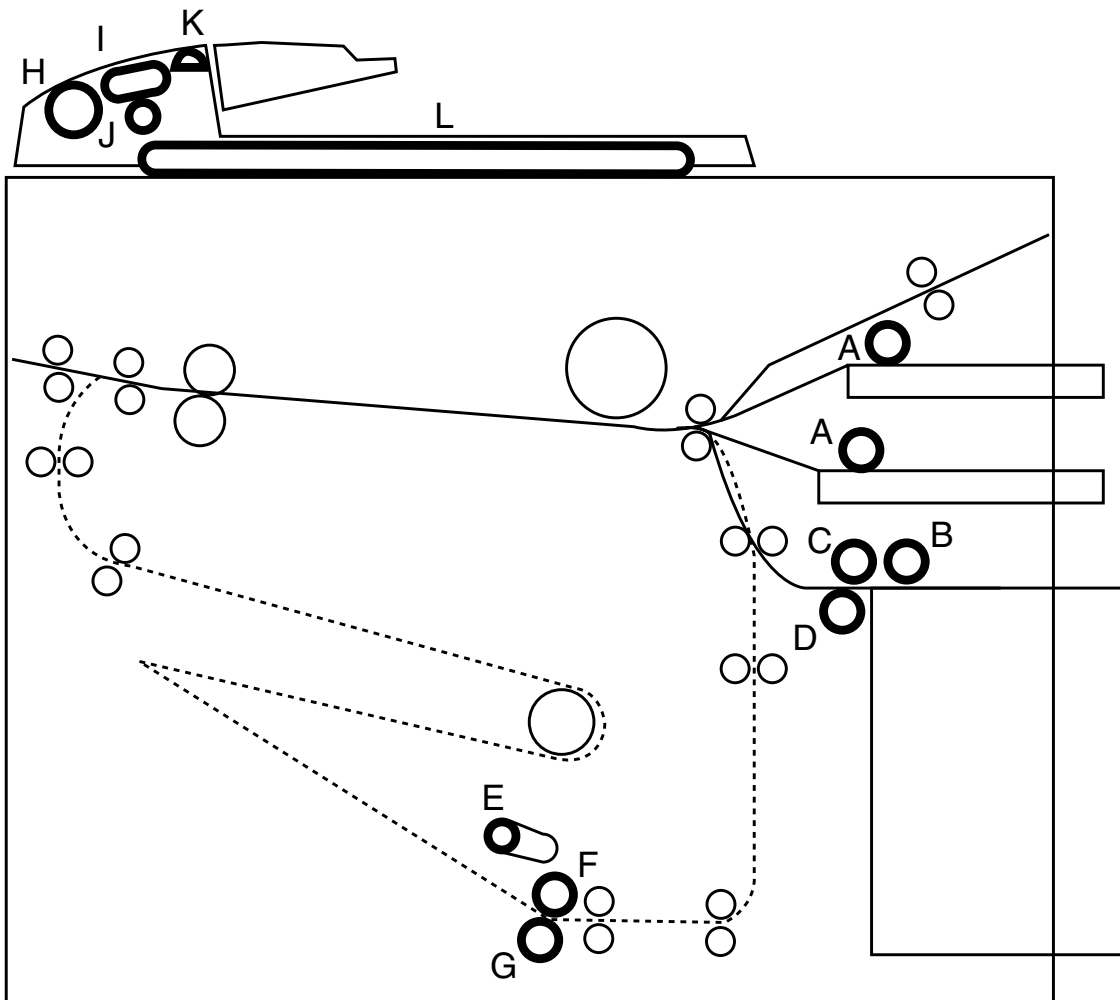

	Description	OEM PN	Katun PN
A	Pickup Roller	FA3-2615-020	15012799
B	Pickup Roller (PD5)	FA5-7789-000	15012798
C	Feed Roller (PD5)	FL9-0009-030	15000886
D	Separation Roller (PD5)	FA6-1038-020	15000892
E	Duplex Pickup Roller	FA3-2615-020	15012799
F	Duplex Feed Roller	FA5-3449-020 FC2-3309-000	15000881
G	Duplex Separation Roller	FA5-5598-030	15000885
H	Reverse Roller (RDF-2)	FA5-5392-000	15011334
H	Reverse Roller (RDF-2) with shaft assembly	FA5-5392-000	15015255
I	Separation Belt (RDF-2)	FA5-5427-000	15015001
J	Feed Roller (RDF-2)	FA5-5416-000	15011368
J	Feed Roller (RDF-2) with shaft assembly	FF2-9926-000	15014698
J	Original Feed Roller (RDF-2)	FF2-9926-000	15019854
K	Pickup Roller (RDF-2) with hub assembly	FA5-5410-000	15011549
L	Document Feed Belt (RDF-2)	FA3-4683-070	15018127
L	Document Feed Belt (RDF-2) with drive coupler	FA3-4683-070	15018127

## REPLACEMENT KITS

	Description	Katun PN
	<b>Feed Roller Kit (Paper Deck) (PD5)</b>	<b>15012653</b>
B	(2) Pickup Rollers	
C	(2) Feed Rollers	
D	(2) Separation Rollers	
	<b>Document Feeder Kit (RDF-2)</b>	<b>15011753</b>
H	(4) Reverse Rollers	
I	(6) Separation Belts	
J	(9) Feed Rollers	
K	(2) Pickup Rollers with hub assembly	
	<b>Document Feeder Kit (RDF-2)</b>	<b>15012139</b>
I	(6) Separation Belts	
J	(9) Feed Rollers	
K	(2) Pickup Rollers with hub assembly	
	<b>RDF Rebuild Kit (RDF-2)</b>	<b>15017473</b>
I	(6) Separation Belts	
J	(1) Feed Roller with shaft assembly	
K	(2) Pickup Rollers with hub assembly	
-	(1) Gear	

## ADDITIONAL KATUN PARTS

Description	OEM PN	Katun PN
Upper Fuser Roller Bearing	FS1-1334-020	15576217
Bearing	XG9-0013-000	15576204
Web Supply Roller	FA5-3720-000	15632388
Web Supply Roller	FY1-1045-000	15632388
Upper Picker Finger	FC1-0391-030	15016086
Corona Wire Spring	97-5527-000	15524647



**Visit [www.katun.com](http://www.katun.com) for the most current cross-reference information and feed component pricing.**